

vivitek[®] User's Manual
Vivid Color, Vivid Life

D965 Series

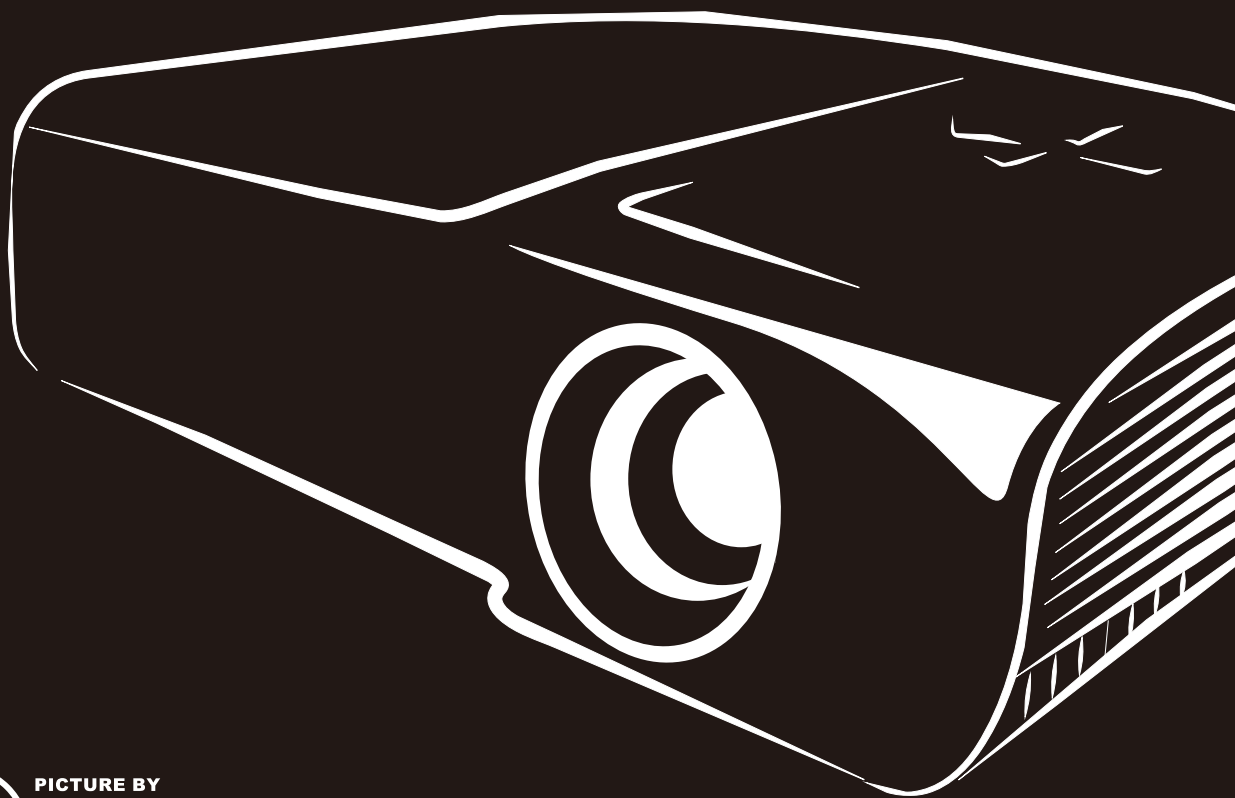

PICTURE BY
DLP[®]
TEXAS INSTRUMENTS

Copyright

This publication, including all photographs, illustrations and software, is protected under international copyright laws, with all rights reserved. Neither this manual, nor any of the material contained herein, may be reproduced without written consent of the author.

© Copyright 2012

Disclaimer

The information in this document is subject to change without notice. The manufacturer makes no representations or warranties with respect to the contents hereof and specifically disclaims any implied warranties of merchantability or fitness for any particular purpose. The manufacturer reserves the right to revise this publication and to make changes from time to time in the content hereof without obligation of the manufacturer to notify any person of such revision or changes.

Trademark Recognition

Kensington is a U.S. registered trademark of ACCO Brand Corporation with issued registrations and pending applications in other countries throughout the world.



HDMI, the HDMI Logo, and High-Definition Multimedia Interface are trademarks or registered trademarks of HDMI Licensing LLC in the United States and other countries.

All other product names used in this manual are the properties of their respective owners and are acknowledged.

Important Safety Information

Important:

It is strongly recommended that you read this section carefully before using the projector. These safety and usage instructions will ensure that you enjoy many years of safe use of the projector. Keep this manual for future reference.

Symbols Used

Warning symbols are used on the unit and in this manual to alert you of hazardous situations.

The following styles are used in this manual to alert you to important information.

Note:

Provides additional information on the topic at hand.

Important:

Provides additional information that should not be overlooked.

Caution:

Alerts you to situations that may damage the unit.

Warning:

Alerts you to situations that may damage the unit, create a hazardous environment, or cause personal injury.

Throughout this manual, component parts and items in the OSD menus are denoted in bold font as in this example:

“Push the **Menu** button on the remote control to open the **Main** menu.”

General Safety Information

- Do not open the unit case. Aside from the projection lamp, there are no user-serviceable parts in the unit. For servicing, contact qualified service personnel.
- Follow all warnings and cautions in this manual and on the unit case.
- The projection lamp is extremely bright by design. To avoid damage to eyes, do not look into the lens when the lamp is on.
- Do not place the unit on an unstable surface, cart, or stand.
- Avoid using the system near water, in direct sunlight, or near a heating device.
- Do not place heavy objects such as books or bags on the unit.

Projector Installation Notice

- Place the projector in a horizontal position
The tilt angle of the projector should not exceed 15 degrees, nor should the projector be installed in any way other than the desktop and ceiling mount, otherwise lamp life could decrease dramatically, and may lead to other **unpredictable damages**.

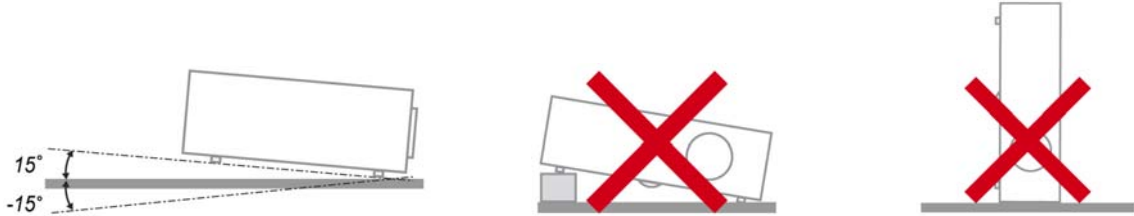

- Allow at least 50 cm clearance around the exhaust vent.

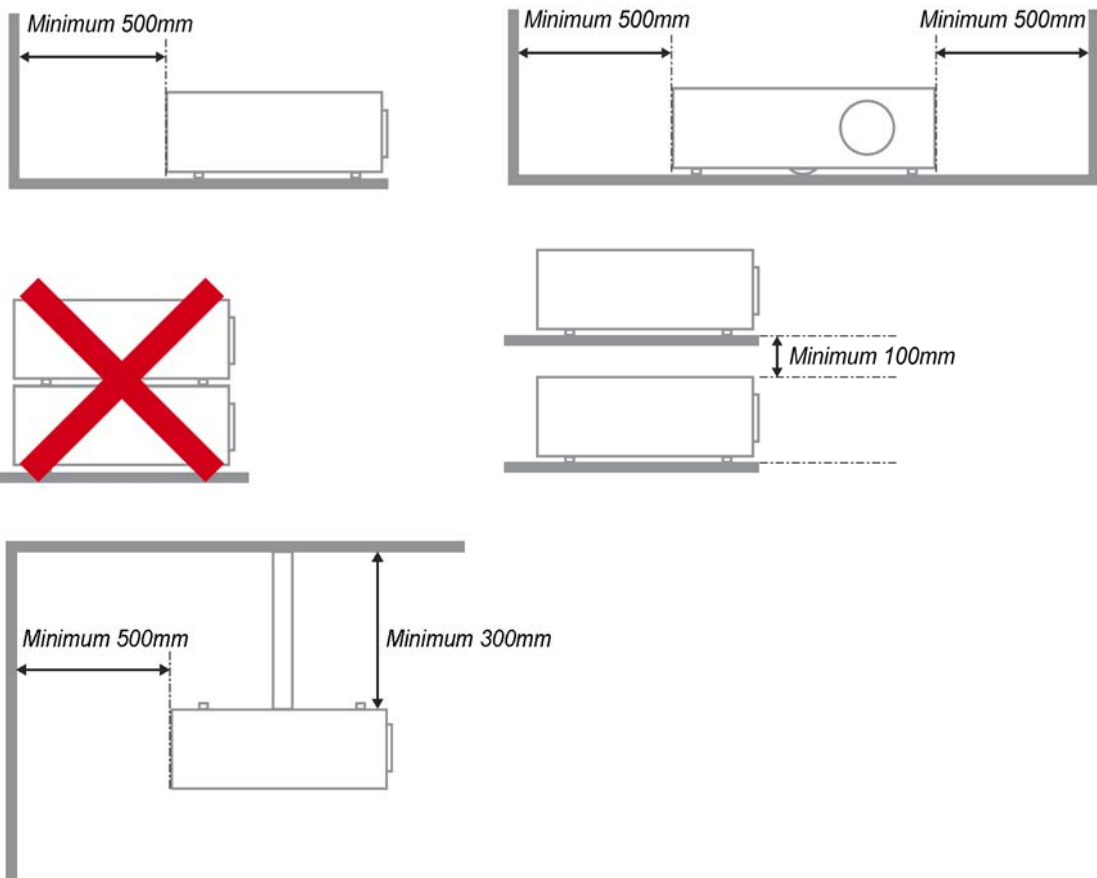

- Ensure that the intake vents do not recycle hot air from the exhaust vent.
- When operating the projector in an enclosed space, ensure that the surrounding air temperature within the enclosure does not exceed operation temperature while the projector is running, and the air intake and exhaust vents are unobstructed.
- All enclosures should pass a certified thermal evaluation to ensure that the projector does not recycle exhaust air, as this may cause the device to shutdown even if the enclosure temperature is within the acceptable operation temperature range.

Verify Installation Location

- Verify if the voltage is stable, grounded properly and there is no electricity leakage.
- Measure total power consumption which should not higher the safety capacity and avoid safety issue and short circuit.
- Turn on Altitude Mode when located in high altitude areas
- The projector can only be installed upright or inverted.
- When installation the bracket, make sure the weight limit is not exceed and firmly secured.
- Avoid installing near air conditioner duct or subwoofer.
- Avoid installing at high temperature, insufficient cooling and heavy dust locations.
- Keep your product away from fluorescent lamps to avoid malfunction caused by IR interference
- Install the projector above 200cm to avoid damage.

Cooling notes

Air outlet

- Make sure the air outlet is 50cm clear of any obstruction to ensure proper cooling.
- Air outlet location should not be in front of the lens of other projector to avoid causing illusions.
- Keep the outlet at least 100cm away from the inlets of other projectors

Air inlet

- Make sure there is no object blocking air input within 30 cm.
- Keep the inlet away from other heat sources
- Avoided heavy dust area

Choosing a Projector

Edge blending application

Not only brightness, bright balances, lens but stability is important too when choosing a projector.

- A projector need 30 to 60 minutes warm up to adjust properly.
- After lens shift, there should not be any optical distortion such as trapezoidal and barrel shape distortions.
- Quick dis-assemble lens need to be firmly secured, the electric motor cannot be mistakenly shift. The screen should not be offset for long time use or during booting up and shutting down the projector.
- Projector six-axis colors (R,G,B,Y,C,W). Projector adjust functions require: Hue, Saturation, Gain
- Vertical or 360 degree projection application. Needs to VERIFY engineering design of lamp aging to avoid conflict with client.

HDMI Cable

Edge blending signal needs to use digital transfer, the 4 pairs of TMDS transfer impedance require 100 Ω diameter as following to maintain signal quality:

- 5 M : AWG 26
- 10 M : AWG 24
- 15 M : AWG 22
- 20 M : AWG 22
- 25 M : AWG 22

Power Safety

- Only use the supplied power cord.
- Do not place anything on the power cord. Place the power cord where it will not be in the way of foot traffic.
- Remove the batteries from the remote control when storing or not in use for a prolonged period.

Replacing the Lamp

Replacing the lamp can be hazardous if done incorrectly. See *Replacing the Projection Lamp* on page 44 for clear and safe instructions for this procedure. Before replacing the lamp:

- Unplug the power cord.
- Allow the lamp to cool for about one hour.

Caution:

In rare cases the lamp bulb may burn out during normal operation and cause glass dust or shards to be discharged outward from the rear exhaust vent.

Do not inhale or do not touch glass dust or shards. Doing so could result in injury.

Always keep your face away from the exhaust vent so that you do not suffer from the gas and broken shards of the lamp.

Cleaning the Projector

- Unplug the power cord before cleaning. See *Cleaning the Projector* on page 48.
- Allow the lamp to cool for about one hour.

Regulatory Warnings

Before installing and using the projector, read the regulatory notices in the *Regulatory Compliance* section on page 58.

Important Recycle Instructions:



Lamp(s) inside this product contain mercury. This product may contain other electronic waste that can be hazardous if not disposed of properly. Recycle or dispose in accordance with local, state, or federal Laws. For more information, contact the Electronic Industries Alliance at WWW.EIAE.ORG. For lamp specific disposal information check WWW.LAMPRECYCLE.ORG.

Symbol Explanations



DISPOSAL: Do not use household or municipal waste collection services for disposal of electrical and electronic equipment. EU countries require the use of separate recycling collection services.

Main Features

- *Lightweight unit, easy to pack away and transport.*
- *Compatible with all major video standards including NTSC, PAL, and SECAM.*
- *A high brightness rating allows for presentations in daylight or in lit rooms.*
- *Supports resolutions up to SXGA+ at 16.7 million colors to deliver crisp, clear images.*
- *Flexible setup allows for front, rear projections.*
- *Line-of-vision projections remain square, with advanced keystone correction for angled projections.*
- *Input source automatically detected.*

About this manual

This manual is intended for end users and describes how to install and operate the DLP projector. Whenever possible, relevant information—such as an illustration and its description—has been kept on one page. This printer-friendly format is both for your convenience and to help save paper, thereby protecting the environment. It is suggested that you only print sections that are relevant to your needs.

Table of Contents

GETTING STARTED.....	1
PACKING CHECKLIST.....	1
VIEWS OF PROJECTOR PARTS.....	2
<i>Front-right View</i>	2
<i>Top view—On-screen Display (OSD) buttons and LEDs</i>	3
<i>Rear view</i>	4
<i>Bottom view</i>	5
REMOTE CONTROL PARTS.....	6
REMOTE CONTROL OPERATING RANGE.....	8
PROJECTOR AND REMOTE CONTROL BUTTONS.....	8
SETUP AND OPERATION.....	9
INSERTING THE REMOTE CONTROL BATTERIES.....	9
STARTING AND SHUTTING DOWN THE PROJECTOR.....	10
SETTING AN ACCESS PASSWORD (SECURITY LOCK).....	12
ADJUSTING THE PROJECTOR LEVEL.....	14
ADJUSTING THE ZOOM RING, FOCUS AND KEYSTONE.....	15
ADJUSTING THE VOLUME.....	16
ON-SCREEN DISPLAY (OSD) MENU SETTINGS.....	17
OSD MENU CONTROLS.....	17
<i>Navigating the OSD</i>	17
SETTING THE OSD LANGUAGE.....	18
OSD MENU OVERVIEW.....	19
OSD SUB-MENU OVERVIEW.....	20
IMAGE MENU.....	21
<i>Advanced Feature</i>	22
<i>Color Manager</i>	23
COMPUTER MENU.....	24
VIDEO/AUDIO MENU.....	25
<i>Audio</i>	26
INSTALLATION I MENU.....	27
<i>Advanced Feature</i>	28
INSTALLATION II MENU.....	29
<i>Advanced Feature</i>	30
<i>OSD Menu Setting</i>	31
<i>Peripheral Test</i>	31
<i>Lamp Hour Reset</i>	32
<i>Network</i>	34
<i>Factory Reset</i>	43
<i>Status</i>	43
MAINTENANCE AND SECURITY.....	44
REPLACING THE PROJECTION LAMP.....	44
<i>Resetting the Lamp</i>	47
CLEANING THE PROJECTOR.....	48
<i>Cleaning the Lens</i>	48
<i>Cleaning the Case</i>	48
USING THE KENSINGTON® LOCK & USING THE SECURITY BAR.....	49
<i>Using the Security Bar</i>	49
TROUBLESHOOTING.....	50
COMMON PROBLEMS AND SOLUTIONS.....	50
TIPS FOR TROUBLESHOOTING.....	50
LED ERROR MESSAGES.....	51
IMAGE PROBLEMS.....	51
LAMP PROBLEMS.....	52
REMOTE CONTROL PROBLEMS.....	52

AUDIO PROBLEMS 52
HAVING THE PROJECTOR SERVICED 52
SPECIFICATIONS 53
 SPECIFICATIONS..... 53
 PROJECTION DISTANCE VS. PROJECTION SIZE..... 54
 Projection Distance and Size Table..... 54
 TIMING MODE TABLE 55
 PROJECTOR DIMENSIONS 57
REGULATORY COMPLIANCE..... 58
 FCC WARNING 58
 CANADA 58
 SAFETY CERTIFICATIONS..... 58
APPENDIX I 59
 RS-232C PROTOCOL..... 59

Packing Checklist

Carefully unpack the projector and check that the following items are included:

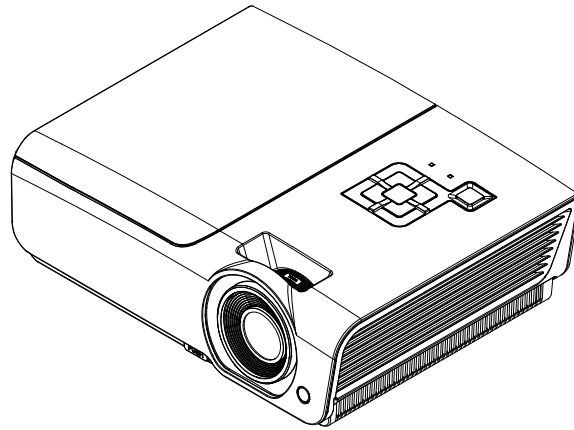

DLP PROJECTOR

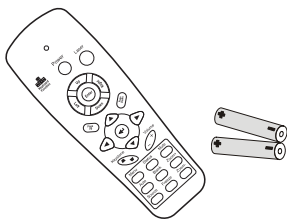

REMOTE CONTROL
(WITH TWO AAA
BATTERIES)

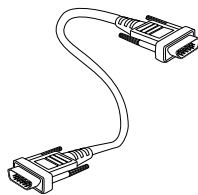

RGB CABLE

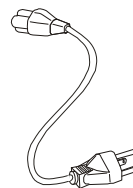

POWER CORD

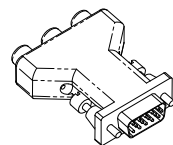

RGB TO COMPONENT
ADAPTER (OPTIONAL)

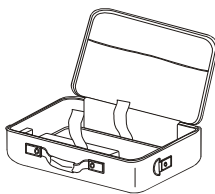

CARRYING CASE



CD-ROM
(THIS USER'S MANUAL)



WARRANTY CARD

Contact your dealer immediately if any items are missing, appear damaged, or if the unit does not work. It is recommended that you keep the original packing material should you ever need to return the equipment for warranty service.

Caution:

Avoid using the projector in dusty environments.

Views of Projector Parts

Front-right View

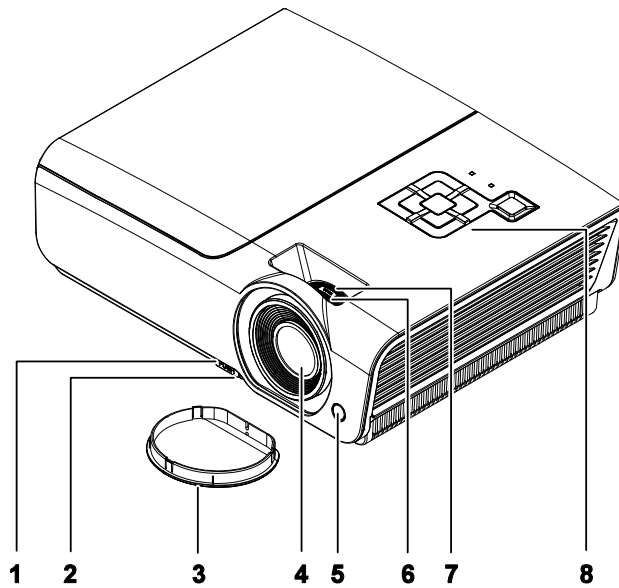

ITEM	LABEL	DESCRIPTION	SEE PAGE:
1.	Height-adjuster button	Push to release height adjuster	14
2.	Height adjuster	Adjusts level of projector	
3.	Lens cap	Protect lens when not in use	
4.	Lens	Projection Lens	
5.	IR receiver	Receive IR signal from remote control	6
6.	Focus ring	Focuses the projected image	15
7.	Zoom ring	Enlarges the projected image	
8.	Function keys	See Top view—On-screen Display (OSD) buttons and LEDs.	3

Important:

Ventilation openings on the projector allow for good air circulation, which keeps the projector lamp cool. Do not obstruct any of the ventilation openings.

Top view—On-screen Display (OSD) buttons and LEDs

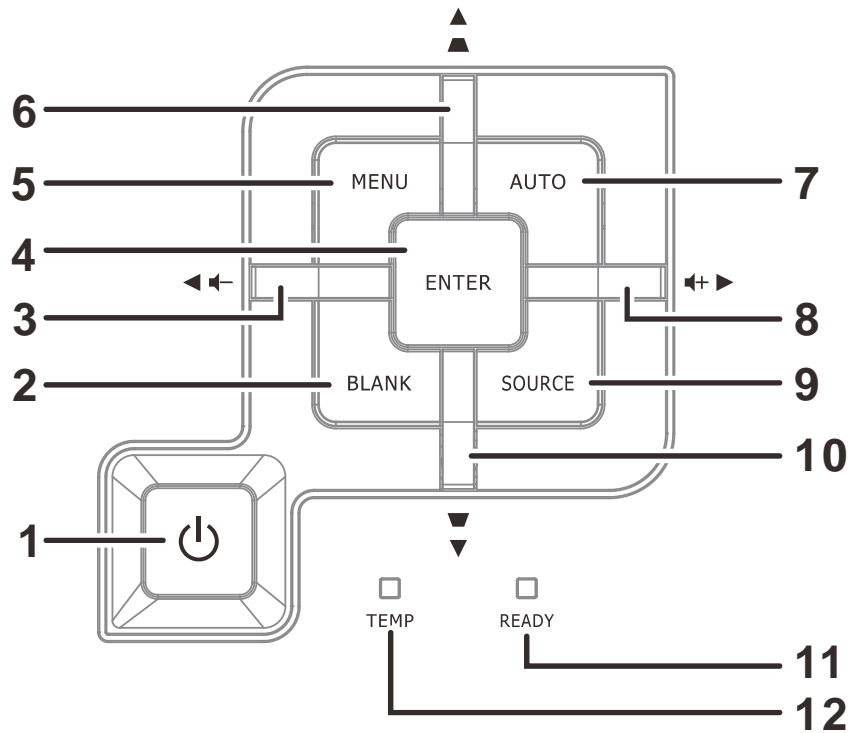

ITEM	LABEL	DESCRIPTION		SEE PAGE:
1.	⏻ (Power button)	Turns the projector On or Off.		10
2.	BLANK	Displays a blank screen and mutes audio		
3.	◀ (Left cursor) / Volume	Navigates and changes settings in the OSD Quick Menu – For Volume		17
4.	Enter	Enter or confirm highlighted OSD menu item		
5.	MENU	Opens and exits OSD menus		
6.	▲ (Up cursor) / Keystone+	Navigates and changes settings in the OSD Quick Menu – For Keystone		
7.	AUTO	Optimizes image size, position, and resolution		
8.	▶ (Right cursor) / Volume	Navigates and changes settings in the OSD Quick Menu – For Volume		17
9.	SOURCE	Enter the Source menu		
10.	▼ (Down cursor) / Keystone-	Navigates and changes settings in the OSD Quick Menu – For Keystone		17
11.	READY LED	Red	Lamp is ready to be powered-on.	
		Flashing	Lamp not ready (Warm-up/shutting down/cooling) (see <i>LED Error Messages</i> on page 51)	
12.	TEMP LED	Red	Error code	

Rear view

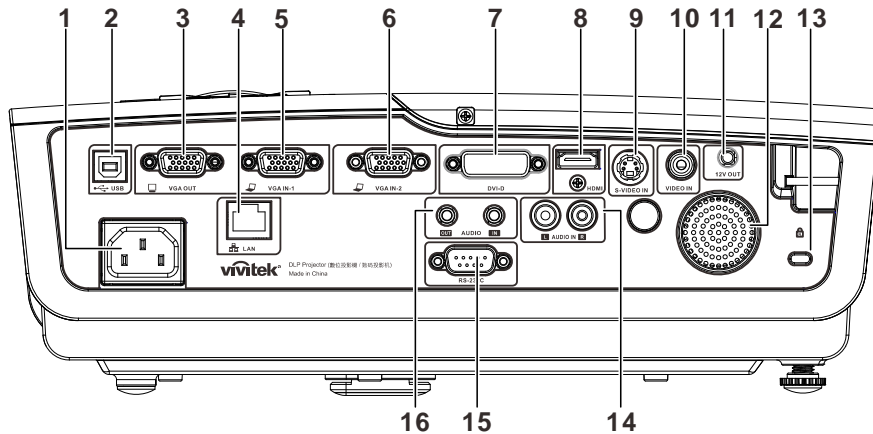

ITEM	LABEL	DESCRIPTION	SEE PAGE:
1.	AC IN	Connect the POWER cable	10
2.	 (USB)	Connect the USB cable from a computer	
3.	VGA OUT	Connect the RGB cable to a display (Loop Thru only for VGA IN-1)	
4.	LAN	Connect a LAN cable from Ethernet	
5.	VGA IN – 1	Connect the RGB cable from a computer or component device	
6.	VGA IN – 2	Connect the RGB cable from a computer or component device	
7.	DVI-D	Connect the DVI cable from a computer	
8.	HDMI	Connect the HDMI cable from a HDMI device	
9.	S-VIDEO IN	Connect the S-Video cable from a video device	
10.	VIDEO IN	Connect the composite cable from a video device	
11.	DC 12V TRIGGER	Connect a 12V screen trigger (200ma max)	
12.	Speaker	Outputs audio sound	
13.	Kensington Lock	Secure to permanent object with a Kensington® Lock system	49
14.	AUDIO IN (L and R)	Connect the audio cable from audio device	
15.	RS-232	Connect RS-232 serial port cable for remote control	
16.	AUDIO IN AUDIO OUT	Connect an AUDIO cable from audio device Connect an AUDIO cable for audio loop through	

Note:

If your video equipment has various input sources, it is recommended to connect in priority of HDMI/DVI, component (thru VGA), S-Video, Composite for better picture quality.

Warning:

As a safety precaution, disconnect all power to the projector and connecting devices before making connections.

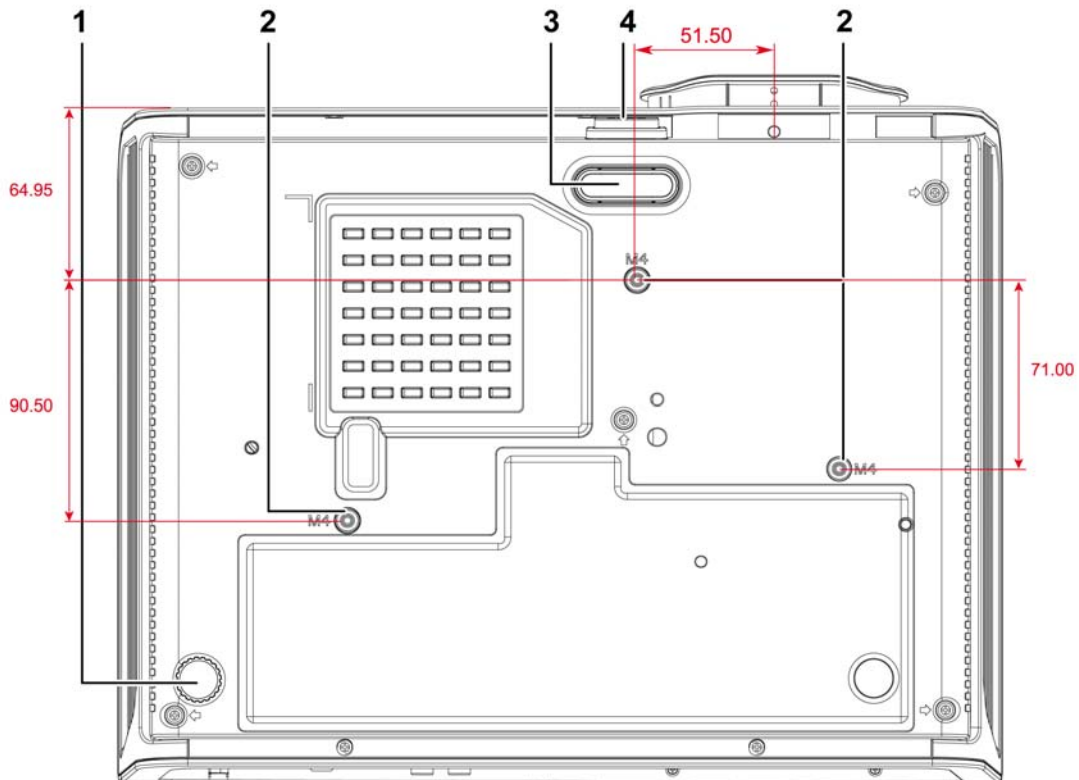
Bottom view

ITEM	LABEL	DESCRIPTION	SEE PAGE:
1.	Tilt adjuster	Rotate adjuster lever to adjust angle position.	14
2.	Ceiling support holes	Contact your dealer for information on mounting the projector on a ceiling	
3.	Height adjuster	Adjuster drops down when adjuster button is pushed.	14
4.	Height adjuster button	Push to release adjuster.	

Note:

When installing, ensure that you use only UL Listed ceiling mounts.

For ceiling installations, use approved mounting hardware and M4 screws with a maximum screw depth of 6 mm (0.23 inch).

The construction of the ceiling mount must be of a suitable shape and strength. The ceiling mount load capacity must exceed the weight of the installed equipment, and as an additional precaution be capable of withstanding three times the weight of the equipment (not less than 5.15 kg) over a period of 60 seconds.

Remote Control Parts

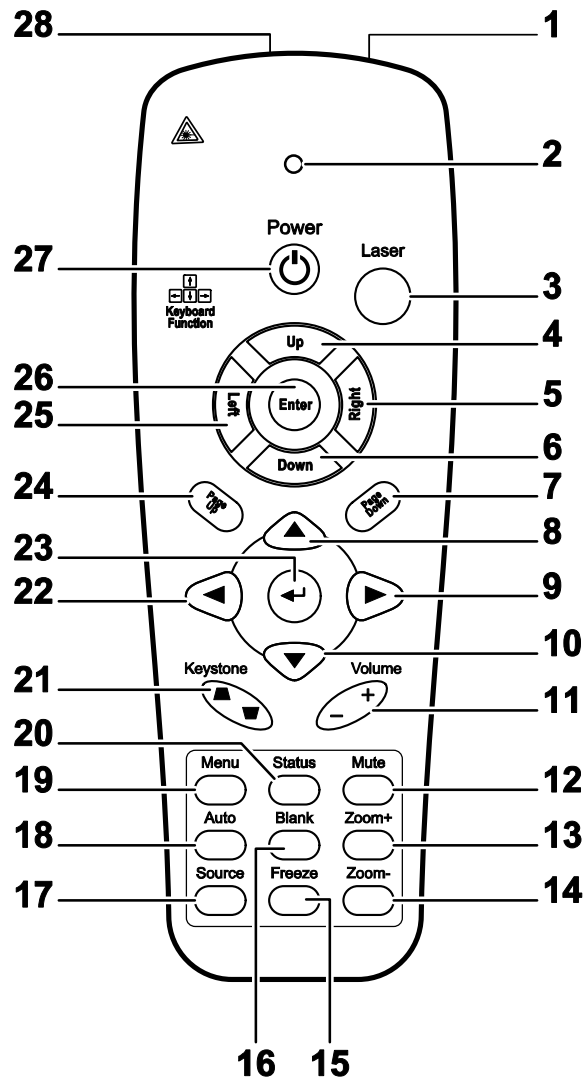

Important:

1. Avoid using the projector with bright fluorescent lighting turned on. Certain high-frequency fluorescent lights can disrupt remote control operation.

2. Be sure nothing obstructs the path between the remote control and the projector. If the path between the remote control and the projector is obstructed, you can bounce the signal off certain reflective surfaces such as projector screens.

3. The buttons and keys on the projector have the same functions as the corresponding buttons on the remote control. This user's manual describes the functions based on the remote control.

ITEM	LABEL	DESCRIPTION	SEE PAGE:
1.	IR transmitter	Transmits signals to projector	
2.	Status LED	Lights when the remote control is used	
3.	Laser	Press to operate the on-screen pointer	
4.	Up	Up arrow when connected through USB to a PC	
5.	Right	Right arrow when connected through USB to a PC	
6.	Down	Down arrow when connected through USB to a PC	
7.	Page Down	Page down when connected through USB to a PC	
8.	Up cursor	Navigates and changes settings in the OSD	17
9.	Right cursor		
10.	Down cursor		
11.	Volume +/-	Adjusts volume	16
12.	Mute	Mutes the built-in speaker	
13.	Zoom+	Zoom in	15
14.	Zoom-	Zoom out	
15.	Freeze	Freeze/unfreezes the on-screen picture	
16.	Blank	Makes the screen blank	
17.	Source	Detects the input device	
18.	Auto	Auto adjustment for phase, tracking, size, position	
19.	Menu	Opens the OSD	17
20.	Status	Opens the OSD Status menu (the menu only opens when an input device is detected)	43
21.	Keystone top/bottom	Corrects image-trapezoid (wider top/bottom) effect	15
22.	Left cursor	Navigates and changes settings in the OSD	17
23.	Enter	Changes settings in the OSD	
24.	Page Up	Page up when connected through USB to a PC	
25.	Left	Left arrow when connected through USB to a PC	
26.	Enter	Enter key when connected through USB to a PC	
27.	Power	Turns the projector on or off	10
28.	Laser	Use as on-screen pointer. DO NOT POINT IN EYES.	

Remote Control Operating Range

The remote control uses infrared transmission to control the projector. It is not necessary to point the remote directly at the projector. Provided you are not holding the remote perpendicular to the sides or the rear of the projector, the remote will function well within a radius of about 7 meters (23 feet) and 15 degrees above or below the projector level. If the projector does not respond to the remote control, move a little closer.

Projector and Remote Control Buttons

The projector can be operated using the remote control or the buttons on the top of the projector. All operations can be carried out with the remote control; however, the buttons on the projector are limited in use.

SETUP AND OPERATION

Inserting the Remote Control Batteries

1. Remove the battery compartment cover by sliding the cover in the direction of the arrow.

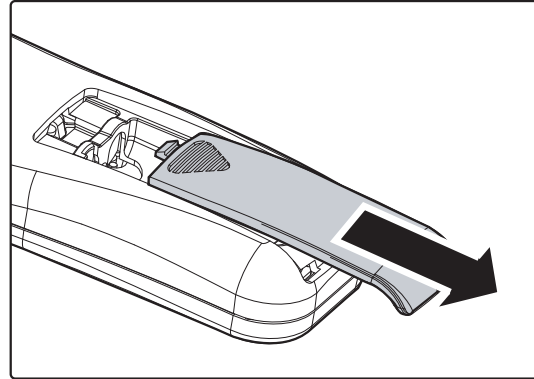

2. Insert the battery with the positive side facing up.

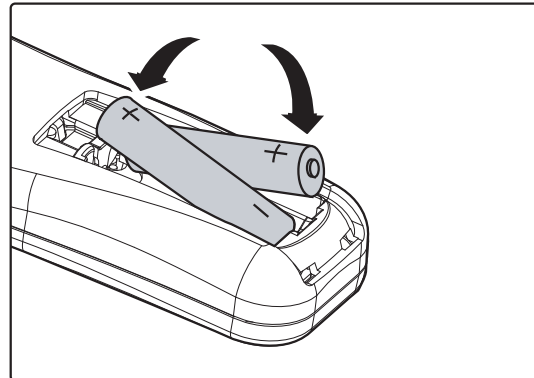

3. Replace the cover.

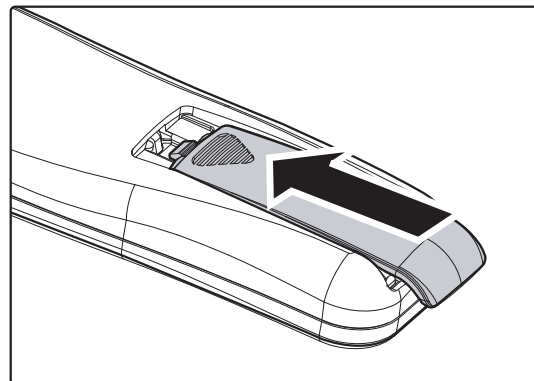

Caution:

1. Only use AAA batteries (Alkaline batteries are recommended).
2. Dispose of used batteries according to local ordinance regulations.
3. Remove the batteries when not using the projector for prolonged periods.

Starting and Shutting down the Projector

1. Connect the power cord to the projector. Connect the other end to a wall outlet.
The  **POWER** and **READY** LEDs on the projector light.

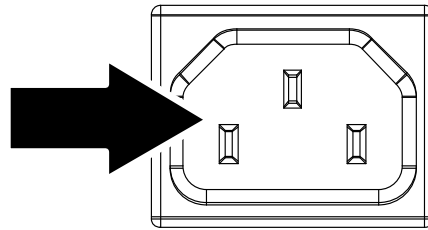



2. Turn on the connected devices.

3. Ensure the **READY** LED displays a solid red and not a flashing red. Then press the  **POWER** button to turn on the projector.

The projector splash screen displays and connected devices are detected.

See *Setting an Access Password (Security Lock)* on page 12 if security lock is enabled.



4. If more than one input device is connected, press the **SOURCE** button and use   to scroll among devices. (Component is supported through the RGB to COMPONENT ADAPTER.)



- VGA 1/VGA 2: Analog RGB
Component: DVD input YCbCr / YPbPr, or HDTV input YPbPr via HD15 connector
- Composite Video: Traditional composite video
- S-Video: S-Video
- DVI: DVI
- HDMI: HDMI, DVI

- 5.** When the “Power Off? /Press Power again” message appears, press the **POWER** button. The projector turns off.



Caution:

1. Be sure to remove the lens cap before starting projector.
2. Do not unplug the power cord until the POWER LED stops flashing—indicating the projector has cooled down.

Setting an Access Password (Security Lock)

You can use the four (arrow) buttons to set a password and prevent unauthorized use of the projector. When enabled, the password must be entered after you power on the projector. (See *Navigating the OSD* on page 17 and *Setting the OSD Language* on page 18 for help on using OSD menus.)

Important:

Keep the password in a safe place. Without the password, you will not be able to use the projector. If you lose the password, contact your reseller for information on clearing the password.

1. Press the **MENU** button to open the OSD menu.
2. Press the cursor ◀▶ button to move to the **Installation I** menu, press the cursor ▲▼ button to select **Advanced**.

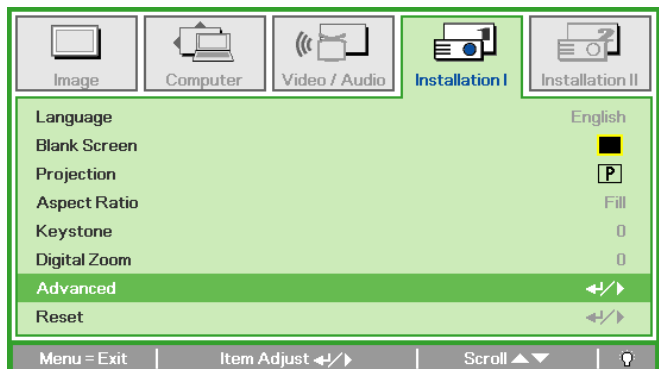
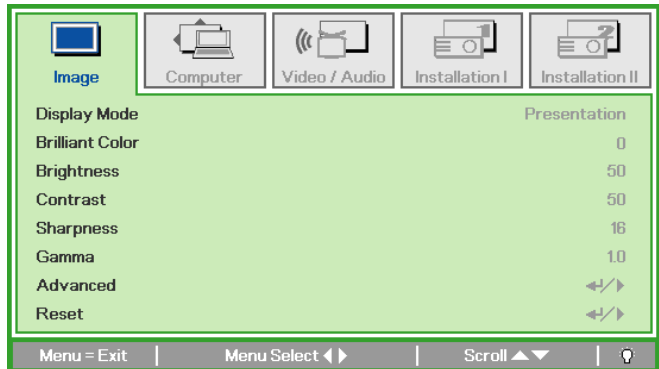

3. Press the cursor ▲▼ button to select **Security Lock**.
4. Press the cursor ◀▶ button to enable or disable security lock function.
A password dialog box automatically appears.

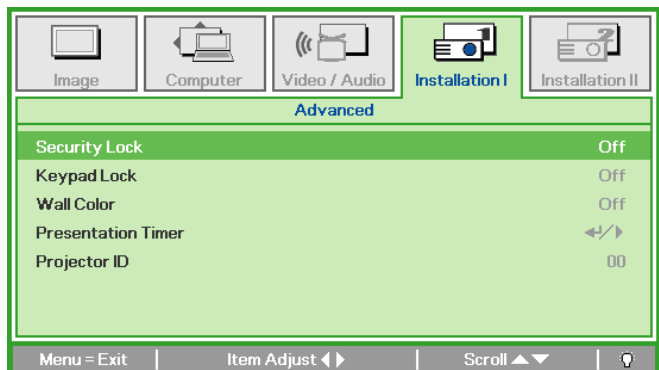

5. You can use the cursor buttons ▲▼◀▶ either on keypad or IR remote control for password entry. You can use any combination including the same arrow five times, but not less than five.

Press the cursor buttons in any order to set the password. Push the **MENU** button to exit the dialog box.

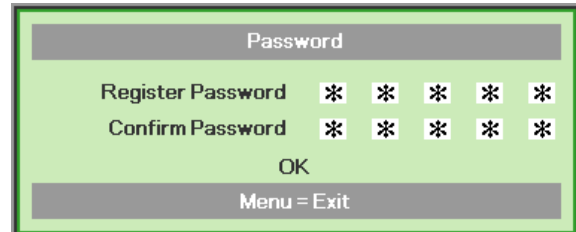
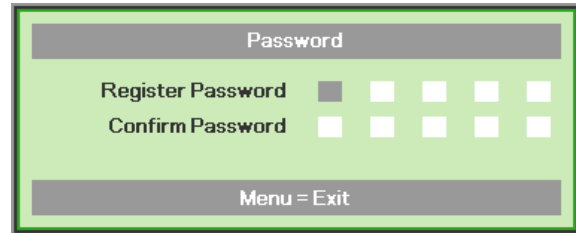

6. The password confirm menu appears when user presses the power-on key in case the **Security Lock** is enabled. Enter the password in the order you set it at step 5. In case you forget the password, please contact the service center. Service center will validate the owner and help reset the password.

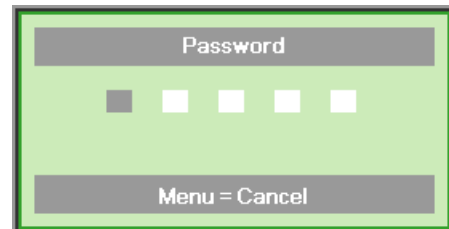

Adjusting the Projector Level

Take note of the following when setting up the projector:

- *The projector table or stand should be level and sturdy.*
- *Position the projector so that it is perpendicular to the screen.*
- *Ensure the cables are in a safe location. You could trip over them.*

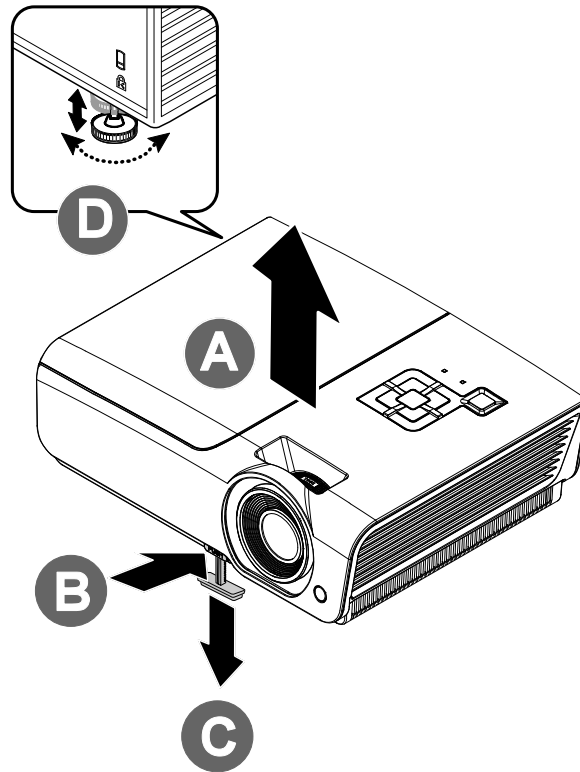

- 1.** To raise the level of the projector, lift the projector **[A]** and press the height-adjuster button **[B]**.

The height adjuster drops down **[C]**.
- 2.** To lower the level of the projector, press the height-adjuster button and push down on the top of the projector.
- 3.** To adjust the angle of the picture, turn the tilt-adjuster **[D]** right or left until the desired angle has been achieved.

Adjusting the Zoom ring, Focus and Keystone

1. Use the **Image-zoom** control (on the projector only) to resize the projected image and screen size **B**.

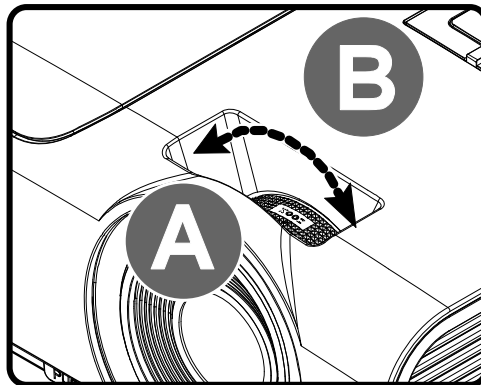

2. Use the **Image-focus** control (on the projector only) to sharpen the projected image **A**.

3. Use the **KEYSTONE** buttons (on the projector or the remote control) to correct image-trapezoid (wider top or bottom) effect.

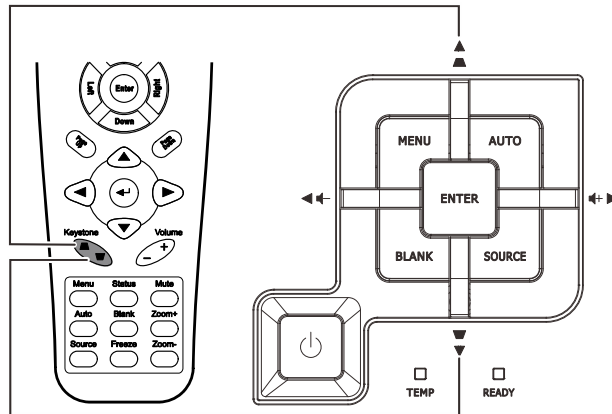

Remote control and OSD panel

4. The keystone control appears on the display.



Adjusting the Volume

1. Press the **Volume +/-** buttons on the remote control.
The volume control appears on the display.

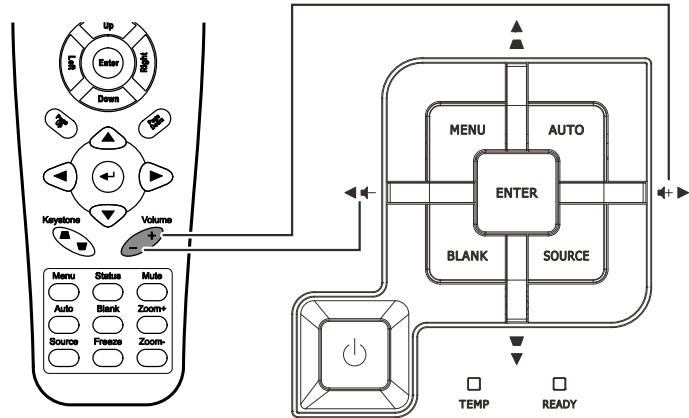

2. Press the **Left** or **Right Cursor** buttons on the keypad to adjust **Volume +/-**.



3. Press the **MUTE** button to turn off the volume (This feature is available only on the remote).



ON-SCREEN DISPLAY (OSD) MENU SETTINGS

OSD Menu Controls

The projector has an OSD that lets you make image adjustments and change various settings.

Navigating the OSD

You can use the remote control cursor buttons or the buttons on the top of the projector to navigate and make changes to the OSD. The following illustration shows the corresponding buttons on the projector.

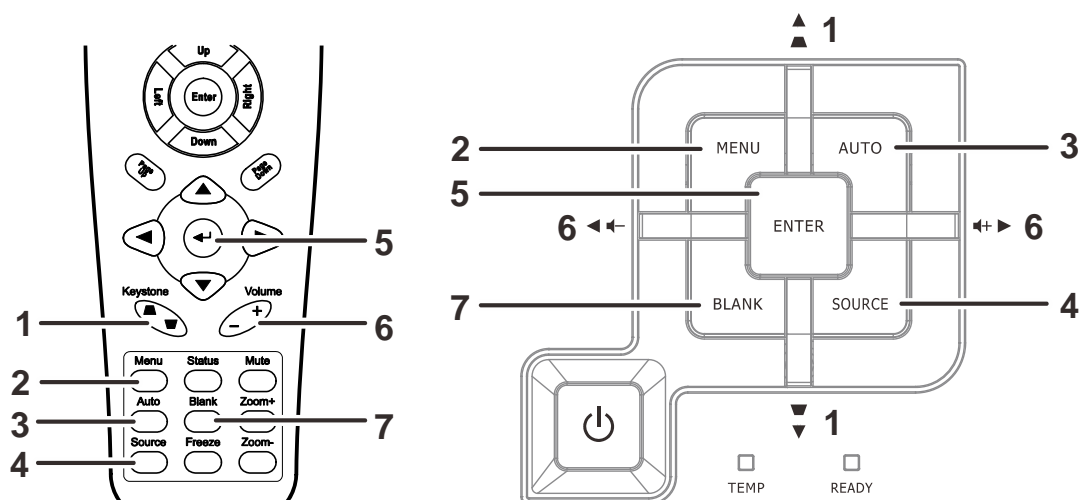

1. To enter the OSD, press the **MENU** button.
2. There are five menus. Press the cursor ◀▶ button to move through the menus.
3. Press the cursor ▲▼ button to move up and down in a menu.
4. Press ◀▶ to change values for settings.
5. Press **MENU** to close the OSD or leave a submenu.

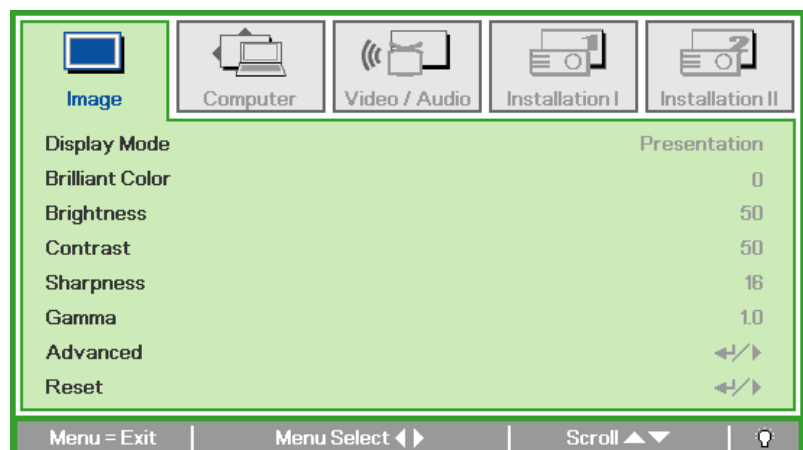

Note:

Depending on the video source, not all items in the OSD are available. For example, the **Horizontal/Vertical Position** items in the **Computer** menu can only be modified when connected to a PC. Items that are not available cannot be accessed and are grayed out.

Setting the OSD Language

Set the OSD language to your preference before continuing.

1. Press the **MENU** button. Press the cursor ◀▶ button to navigate to Installation I.

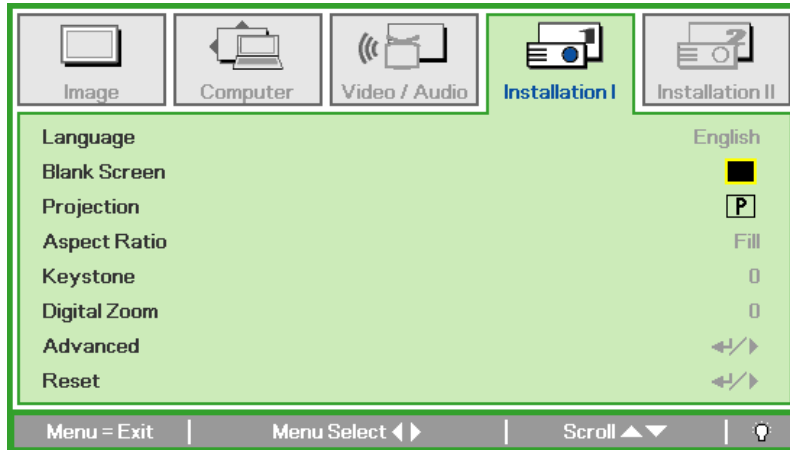

2. Press the cursor ▲▼ button until **Language** is highlighted.

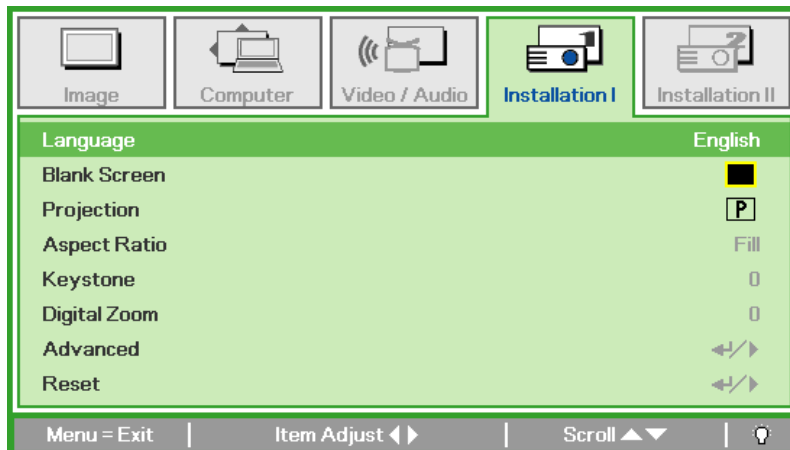

3. Press the cursor ◀▶ button until the language you want is highlighted.
4. Press the **MENU** button twice to close the OSD.

OSD Menu Overview

Use the following illustration to quickly find a setting or determine the range for a setting.

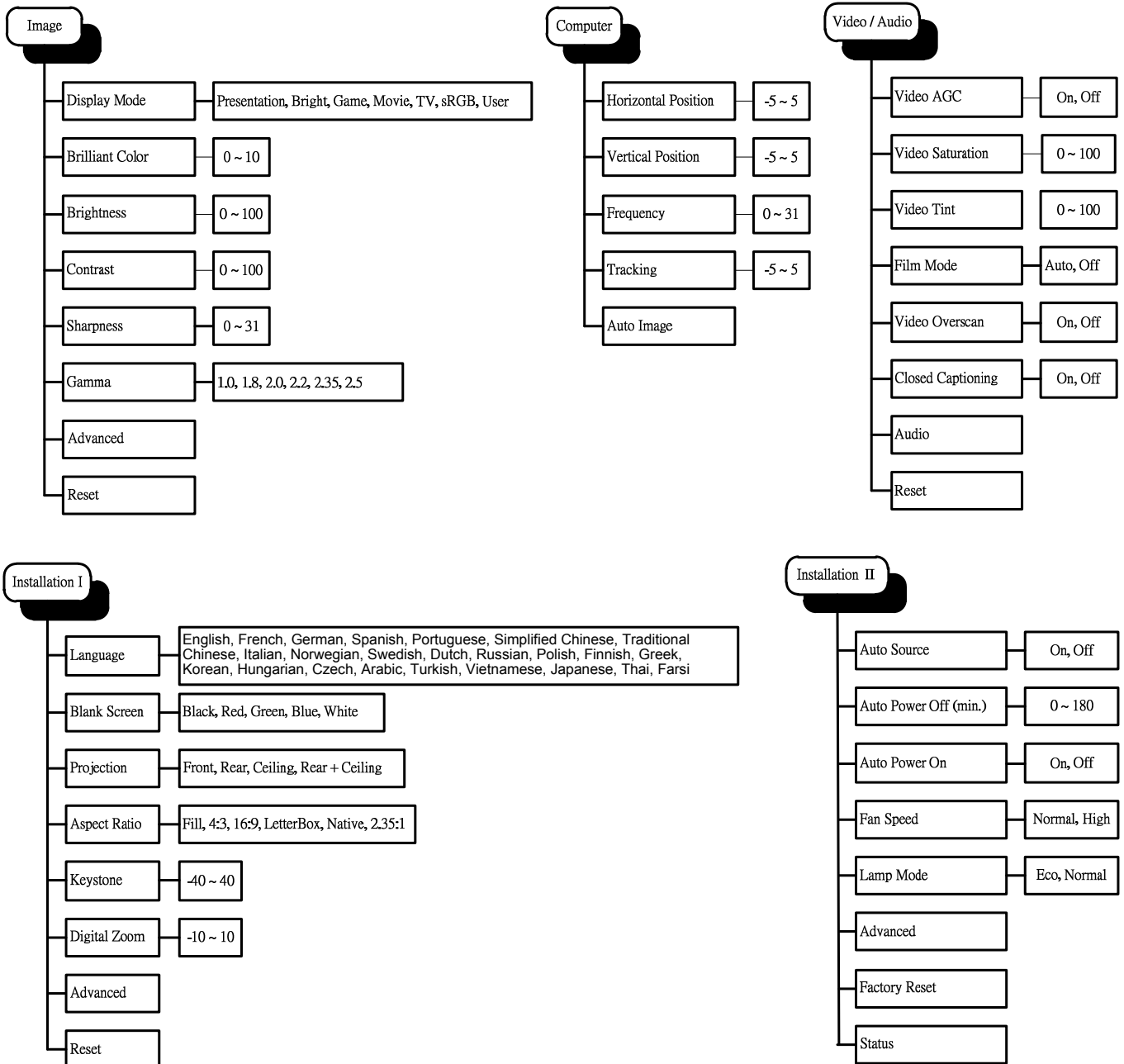

OSD Sub-Menu Overview

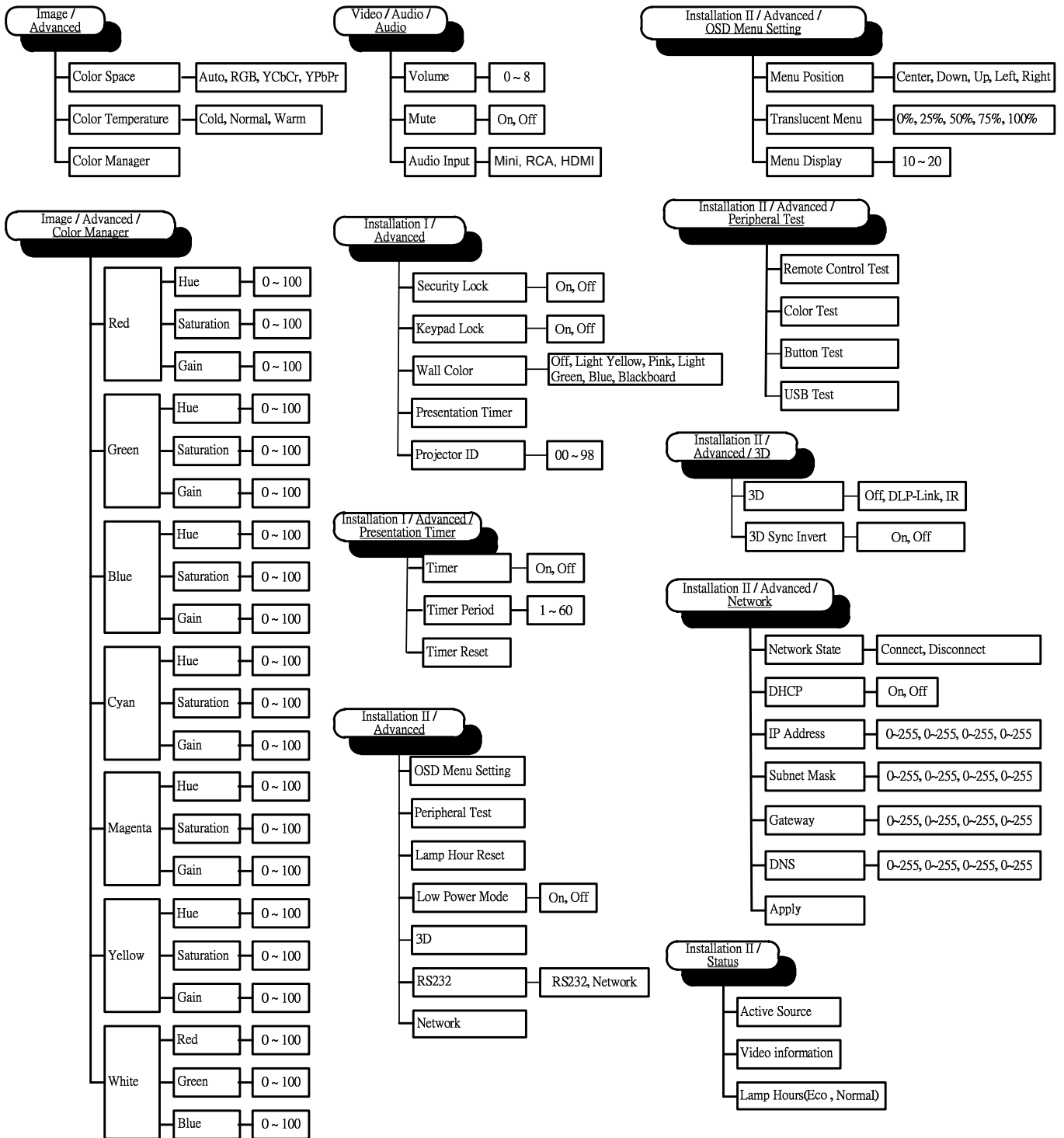
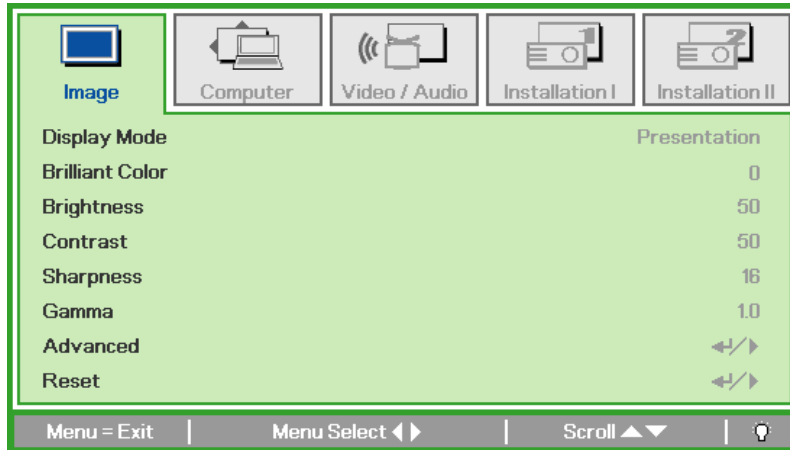

Image Menu

Press the **MENU** button to open the **OSD** menu. Press the cursor **◀▶** button to move to the **Image Menu**. Press the cursor **▲▼** button to move up and down in the **Image** menu. Press **◀▶** to change values for settings.



ITEM	DESCRIPTION
Display Mode	Press the cursor ◀▶ button to set the Display Mode.
Brilliant Color	Press the cursor ◀▶ button to adjust the Brilliant Color value.
Brightness	Press the cursor ◀▶ button to adjust the display brightness.
Contrast	Press the cursor ◀▶ button to adjust the display contrast.
Sharpness	Press the cursor ◀▶ button to adjust the display sharpness level.
Gamma	Press the cursor ◀▶ button to adjust the gamma correction of the display.
Advanced	Press ↵ (Enter) / ▶ to enter the Advanced menu. See <i>Advanced Feature</i> on page 22.
Reset	Press ↵ (Enter) / ▶ to reset all settings to default values.

Advanced Feature

Press the **Menu** button to open the **OSD** menu. Press ◀▶ to move to the **Image** menu. Press ▼▲ to move to the **Advanced** menu and then press **Enter** or ▶. Press ▼▲ to move up and down in the **Advanced** menu.

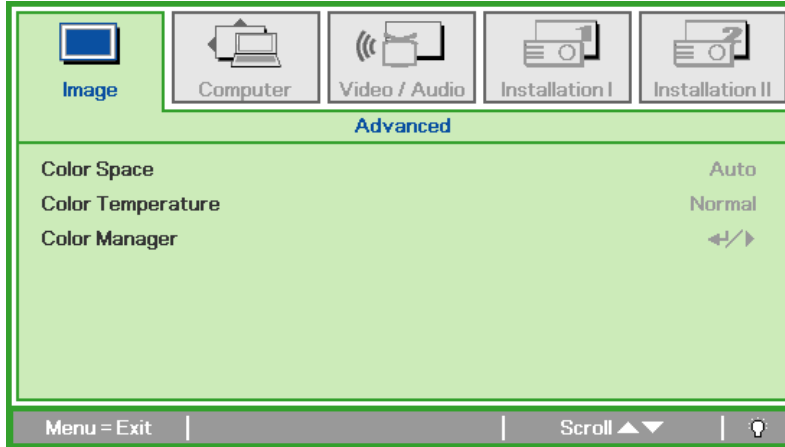

ITEM	DESCRIPTION
Color Space	Press the cursor ◀▶ button to adjust the color space. (Range: Auto – RGB – YPbPr – YCbCr)
Color Temperature	Press the cursor ◀▶ button to adjust the color temperature. (Range: Cold – Normal – Warm)
Color Manager	Press ◀ (Enter) / ▶ to enter the color manager menu. (Range: Red-Green-Blue-Cyan-Magenta-Yellow-White). See page 23 for more information on Color Manager.

Color Manager

Press ◀ (Enter) / ▶ to enter the **Color Manager** sub menu.

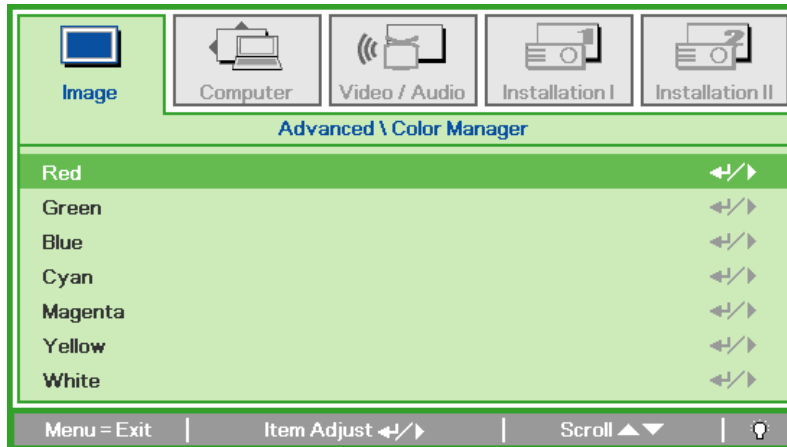

ITEM	DESCRIPTION
Red	Select to enter the Red Color Manager. Press the ◀▶ buttons to adjust the Hue, Saturation, and Gain.
Green	Select to enter the Green Color Manager. Press the ◀▶ buttons to adjust the Hue, Saturation, and Gain.
Blue	Select to enter the Blue Color Manager. Press the ◀▶ buttons to adjust the Hue, Saturation, and Gain.
Cyan	Select to enter the Cyan Color Manager. Press the ◀▶ buttons to adjust the Hue, Saturation, and Gain.
Magenta	Select to enter the Magenta Color Manager. Press the ◀▶ buttons to adjust the Hue, Saturation, and Gain.
Yellow	Select to enter the Yellow Color Manager. Press the ◀▶ buttons to adjust the Hue, Saturation, and Gain.
White	Select to enter the White Color Manager. Press the ◀▶ buttons to adjust the Red, Green, and Blue.

Computer Menu

Press the **MENU** button to open the **OSD** menu. Press the cursor **◀▶** button to move to the **Computer** menu. Press the cursor **▲▼** button to move up and down in the computer menu. Press **◀▶** to change values for settings.

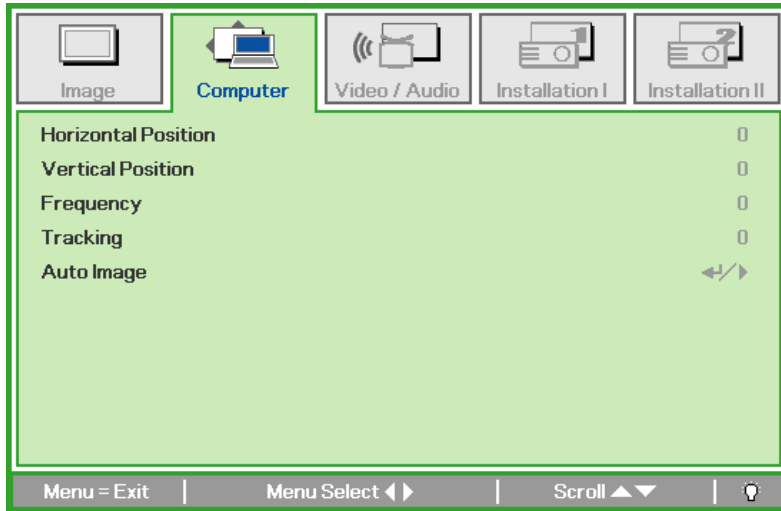

ITEM	DESCRIPTION
Horizontal Position	Press the cursor ◀▶ button to adjust the display position to left or right.
Vertical Position	Press the cursor ◀▶ button to adjust the display position to up or down.
Frequency	Press the cursor ◀▶ button to adjust the A/D sampling clock.
Tracking	Press the cursor ◀▶ button to adjust the A/D sampling dot.
Auto Image	Press ↵ (Enter) / ▶ to automatically adjustment for phase, tracking, size and position.

Video/Audio Menu

Press the **MENU** button to open the **OSD** menu. Press the cursor ◀▶ button to move to the **Video/Audio** menu. Press the cursor ▲▼ button to move up and down in the **Video/Audio** menu. Press ◀▶ to change values for settings.

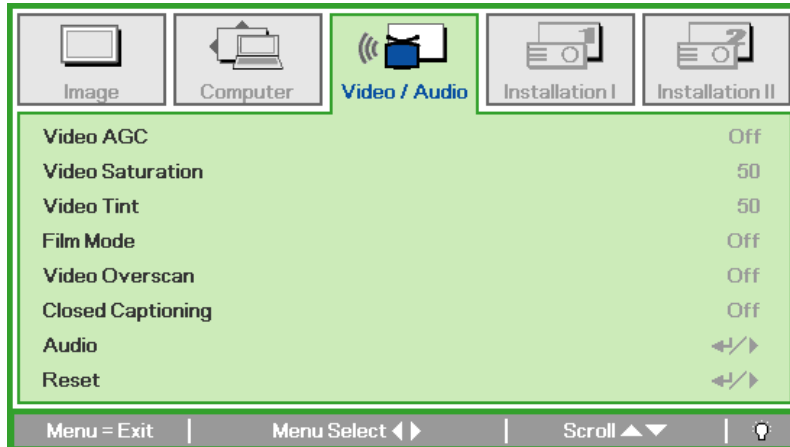

ITEM	DESCRIPTION
Video AGC	Press the ◀▶ buttons to enable or disable the Automatic Gain Control for video source.
Video Saturation	Press the ◀▶ buttons to adjust the video saturation.
Video Tint	Press the ◀▶ buttons to adjust the video tint/hue.
Film Mode	Press the ◀▶ buttons to select a different film mode.
Video Overscan	Press the ◀▶ buttons to enable or disable video over scan.
Closed Captioning	Press the ◀▶ buttons to enable or disable Closed Captioning
Audio	Press ◀ (Enter) / ▶ to enter the Audio menu. See <i>Audio</i> on page 26.
Reset	Press ◀ (Enter) / ▶ to reset all settings to default values.

Note:

Video jaggging may occur when playing interlace video. To overcome this issue, open the Video / Audio menu and adjust the Film Mode feature.

Audio

Press ◀ (Enter) / ▶ to enter the **Audio** sub menu.

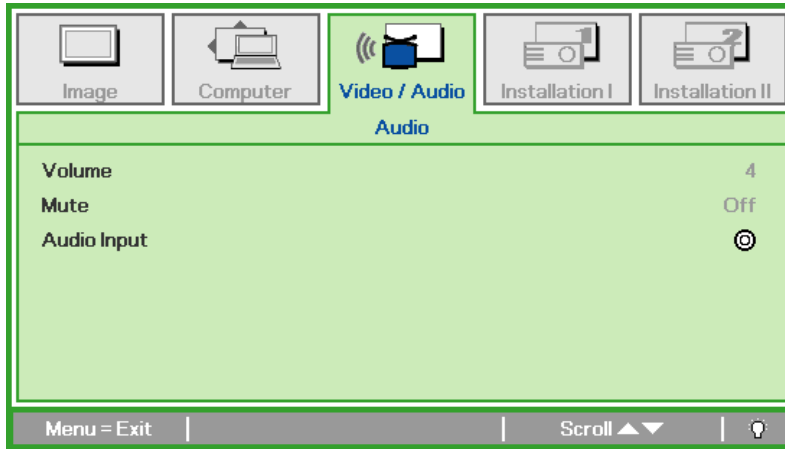

ITEM	DESCRIPTION
Volume	Press the ◀▶ buttons to adjust the audio volume. (Range: 0 ~ 8)
Mute	Press the ◀▶ buttons to turn on or off the speaker.
Audio Input	Press the cursor ◀▶ button to select audio input. (Range: Mini / RCA / HDMI)

Installation I Menu

Press the **MENU** button to open the **OSD** menu. Press the cursor ◀▶ button to move to the **Installation I** menu. Press the cursor ▲▼ button to move up and down in the **Installation I** menu. Press ◀▶ to change values for settings.

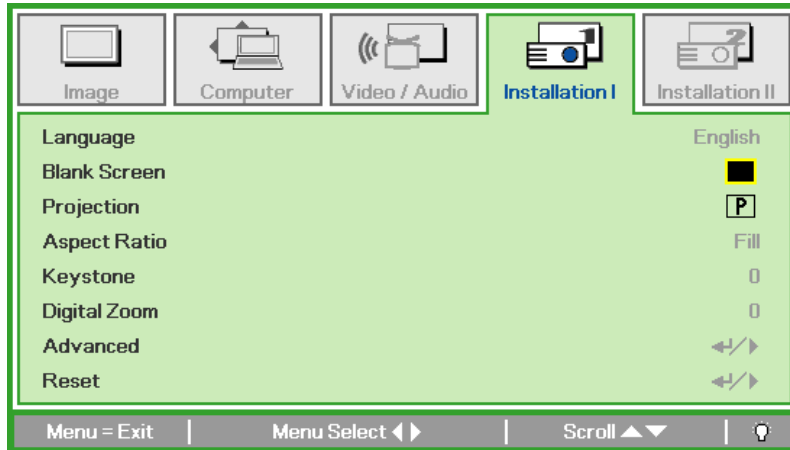

ITEM	DESCRIPTION
Language	Press the cursor ◀▶ button to select a different localization Menu.
Blank Screen	Press the cursor ◀▶ button to select different color to blank the screen.
Projection	Press the cursor ◀▶ button to choose from four projection methods:
Aspect Ratio	Press the cursor ◀▶ button to adjust the video aspect ratio.
Keystone	Press the cursor ◀▶ button to adjust the display keystone.
Digital Zoom	Press the cursor ◀▶ button to adjust the Digital Zoom menu.
Advanced	Press ◀ (Enter) / ▶ to enter the Advanced menu. See <i>Advanced Feature</i> on page 30.
Reset	Press ◀ (Enter) / ▶ to reset all settings to default values (except Language and Security Lock).

Advanced Feature

Press the **Menu** button to open the **OSD** menu. Press **◀▶** to move to the **Installation I** menu. Press **▲▼** to move to the **Advanced** menu and then press **Enter** or **▶**. Press **▲▼** to move up and down in the **Advanced** menu. Press **◀▶** to change values for setting.

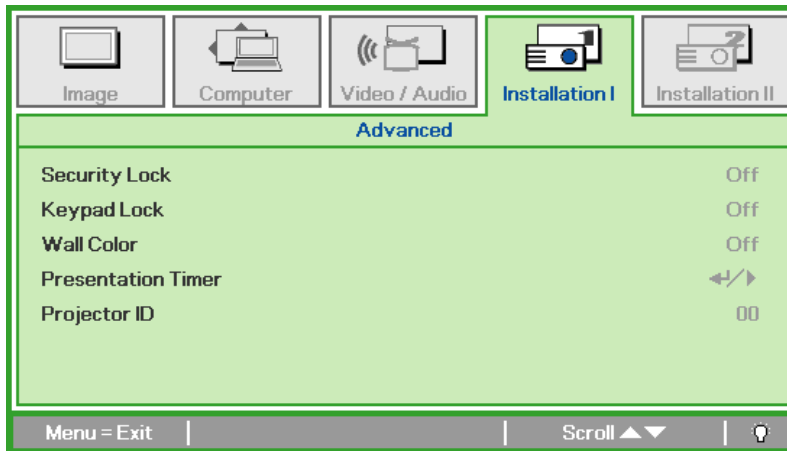

ITEM	DESCRIPTION
Security Lock	Press the cursor ◀▶ button to enable or disable security lock function.
Keypad Lock	Press the cursor ◀▶ button to enable or disable keys can be work on keypad.
Wall Color	Press the cursor ◀▶ button to select different wall color setting.
Presentation Timer	Press ◀ (Enter) / ▶ to enter the Presentation menu. See <i>Advanced Feature</i> on page 28.
Projector ID	Press the cursor ◀▶ button to adjust a two digit projector ID from 0 through 98.

Presentation Timer

The Presentation Timer function can indicate the presentation time on the screen to help you achieve better time management when giving presentations.

Press **◀** (Enter) / **▶** to enter the **Presentation Timer** sub menu.

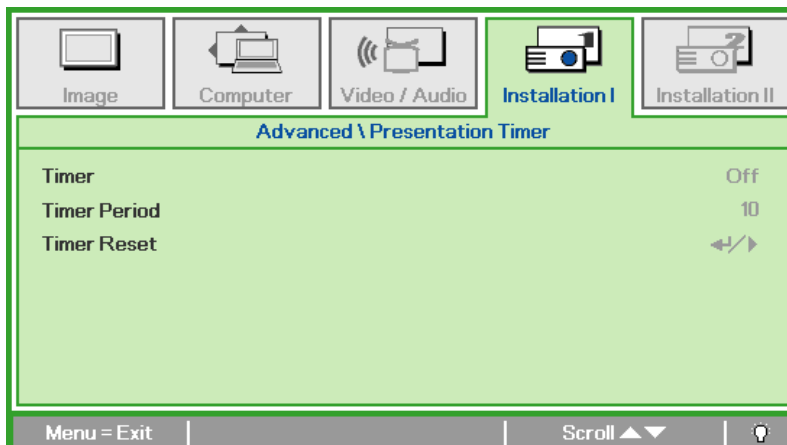

ITEM	DESCRIPTION
Timer	Press the cursor ◀▶ button to enable or disable presentation timer function.
Timer Period	Press the cursor ◀▶ button to adjust the display timer period.
Timer Reset	Press ◀ (Enter) / ▶ to reset presentation timer counter.

Installation II Menu

Press the **MENU** button to open the **OSD** menu. Press the cursor ◀▶ button to move to the **Installation II** menu. Press the cursor ▲▼ button to move up and down in the Installation II menu.

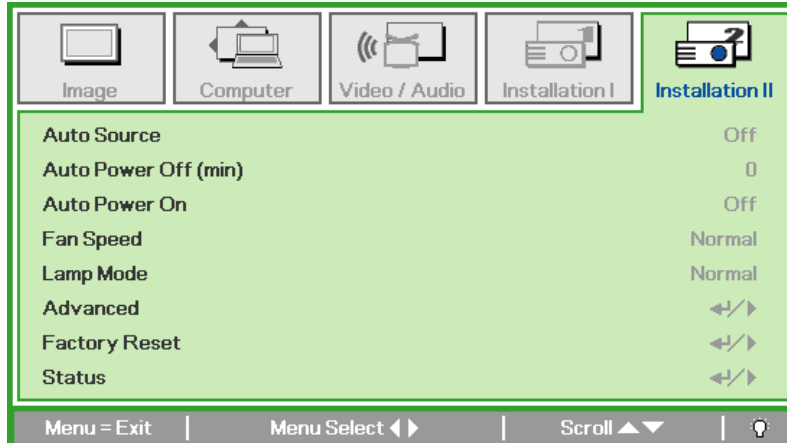

ITEM	DESCRIPTION
Auto Source	Press the cursor ◀▶ button to enable or disable automatic source detection.
Auto Power Off (min.)	Press the cursor ◀▶ button to enable or disable automatic shutdown of lamp when no signal.
Auto Power On	Press the cursor ◀▶ button to enable or disable automatic power On when AC power is supplied.
Fan Speed	Press the cursor ◀▶ button to toggle between Normal and High fan speeds. Note: We recommend selecting high speed in high temperatures, high humidity, or high altitude (above 1500m/4921ft) areas.
Lamp Mode	Press the cursor ◀▶ button to select the lamp mode for higher brightness or lower brightness to save lamp life.
Advanced	Press ◀ (Enter) / ▶ to enter the Advanced menu. See <i>Advanced Feature</i> on page 30.
Factory Reset	Press ◀ (Enter) / ▶ to reset all items to factory preset values.
Status	Press ◀ (Enter) / ▶ to enter the Status menu. See page 43 for more information on Status.

Advanced Feature

Press the **Menu** button to open the **OSD** menu. Press ◀▶ to move to the **Installation II** menu. Press ▲▼ to move to the **Advanced** menu and then press **Enter** or ▶. Press ▲▼ to move up and down in the **Advanced** menu. Press ◀▶ to change values for setting.

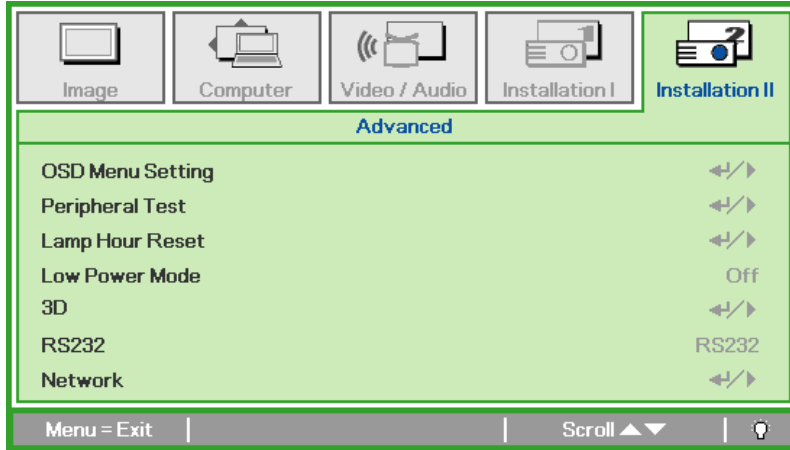

ITEM	DESCRIPTION
OSD Menu Setting	Press ◀ (Enter) / ▶ to enter the OSD setting menu. See page 31 for more information on OSD Menu Setting.
Peripheral Test	Press ◀ (Enter) / ▶ to enter the Peripheral Test menu. See page 31 for more information on Peripheral Test.
Lamp Hour Reset	After replacing the lamp, this item should be reset. See page 32 for more information on Lamp Hour Reset.
Low Power Mode	Press ◀▶ to turn Low Power Mode on or off.
3D	Press ◀ (Enter) / ▶ to enter the 3D menu. See page 33 for more information on 3D setting..
RS232	Press ◀▶ to select RS232 (remote) or Network (LAN) mode depending on projector connection method.
Network	Press ◀ (Enter) / ▶ to enter the Network menu. See page 34 for more information on Network settings.

OSD Menu Setting

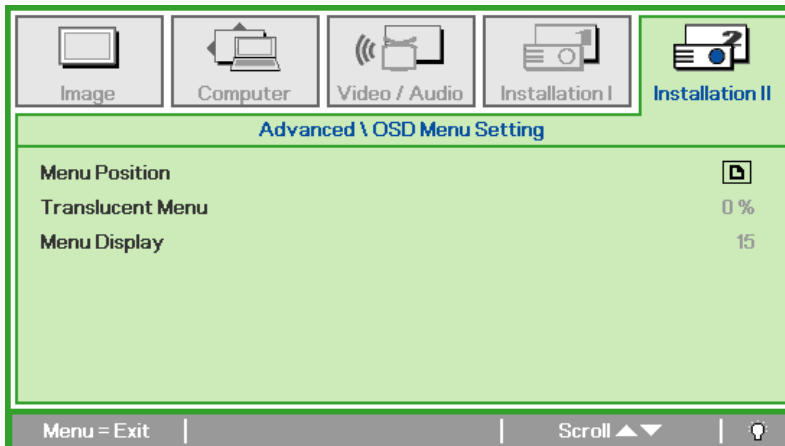

ITEM	DESCRIPTION
Menu Position	Press ◀▶ button to select different OSD location.
Translucent Menu	Press ◀▶ button to select OSD background translucent level.
Menu Display	Press ◀▶ button to select OSD timeout delay.

Peripheral Test

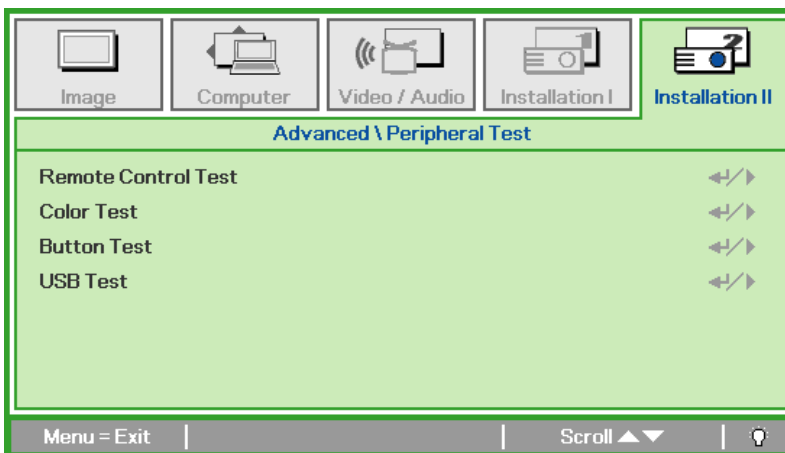

ITEM	DESCRIPTION
Remote Control Test	Press ◀ (Enter) / ▶ to test the IR remote controller for diagnostic.
Color Test	Press ◀ (Enter) / ▶ to select different colors on screen.
Button Test	Press ◀ (Enter) / ▶ to test the button on keypad.
USB Test	Press ◀ (Enter) / ▶ to test the USB connection with connected PC.

Lamp Hour Reset

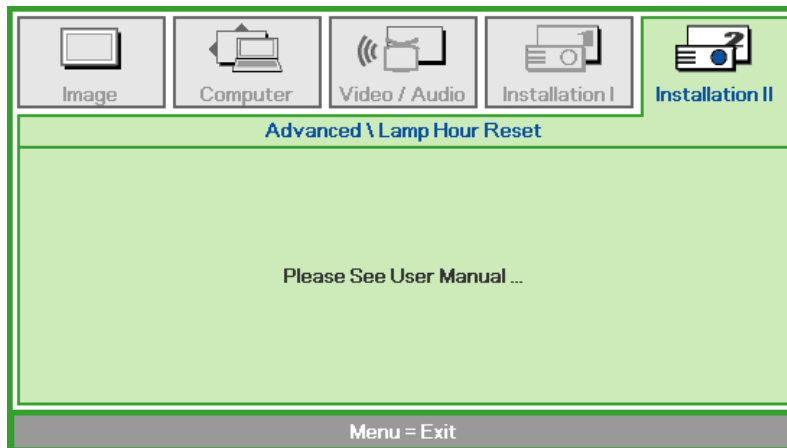

Please refer to *Resetting the Lamp* on page 47 to reset the lamp hour counter.

3D

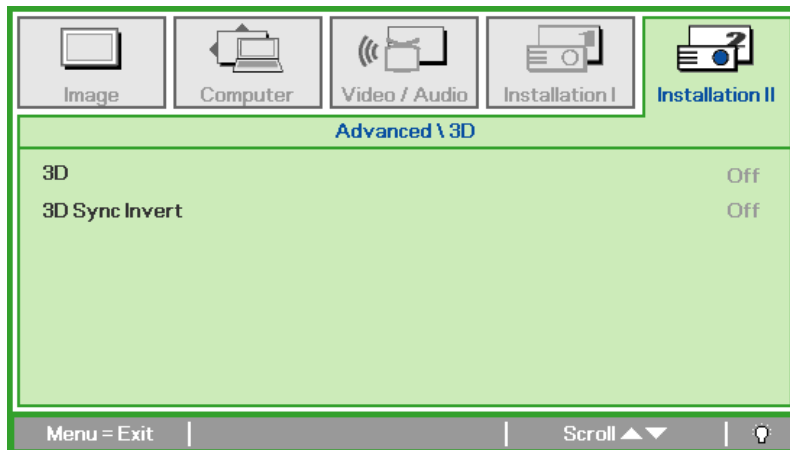

ITEM	DESCRIPTION
3D	Press the cursor ◀▶ button to select different 3D mode.
3D Sync Invert	Press the cursor ◀▶ button to enable or disable 3D Sync Invert.

Note:

1. The 3D OSD menu item is gray if there is no appropriate 3D source. This is the default setting.
2. When the projector is connected to an appropriate 3D source, the 3D OSD menu item is enabled for selection.
3. Use 3D glasses to view a 3D image.
4. You need 3D content from a 3D DVD or 3D media file.
5. You need to enable the 3D source (some 3D DVD content may have a 3D on-off selection feature).
6. You need DLP link 3D or IR 3D shutter glasses. With IR 3D shutter glasses, you need to install a driver on your PC and connect a USB emitter.
7. The 3D mode of the OSD needs to match the type of glasses (DLP link or IR 3D).
8. Power on the glasses. Glasses normally have a power on -off switch. Each type of glasses has their own configuration instructions. Please follow the configuration instructions that come with your glasses to finish the setup process.

Note:

Since different types of glass (DLP link or IR shutter glass) have their own setting instructions, Please follow the guide to finish the setup process.

Network

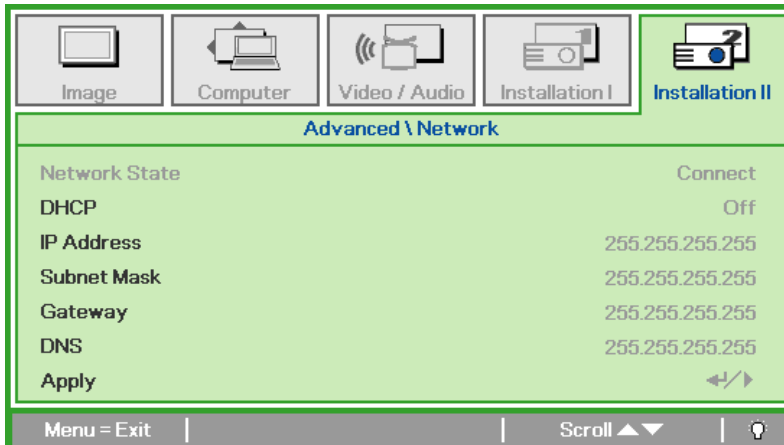

ITEM	DESCRIPTION
Network State	Displays the network connection status.
DHCP	Press ◀▶ to turn DHCP On or Off. Note: If you select DHCP Off, complete the IP Address, Subnet Mask, Gateway, and DNS fields.
IP Address	Enter a valid IP address if DHCP is turned off.
Subnet Mask	Enter a valid Subnet Mask if DHCP is turned off.
Gateway	Enter a valid Gateway address if DHCP is turned off.
DNS	Enter a valid DNS name if DHCP is turned off.
Apply	Press ◀ (Enter) / ▶ to confirm settings.

For simplicity and ease of operation, the projector provides diverse networking and remote management features.

The LAN/RJ45 function of the projector through a network, such as remotely manage: Power On/Off, Brightness and Contrast settings. Also, projector status information, such as: Video-Source, Sound-Mute, etc.

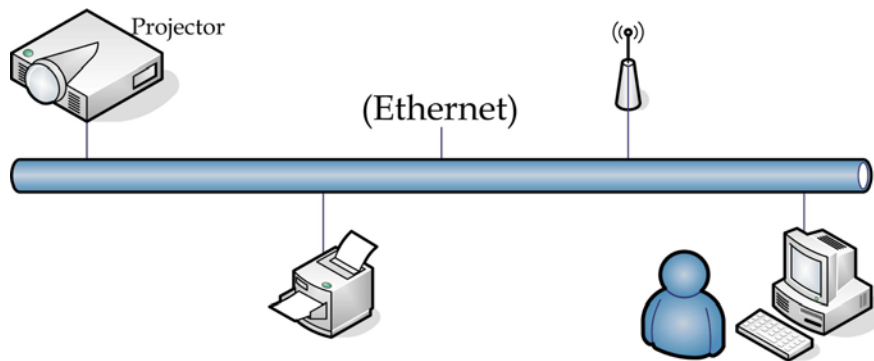

LAN RJ45

1. Connect an RJ45 cable to RJ45 ports on the projector and the PC (Laptop).

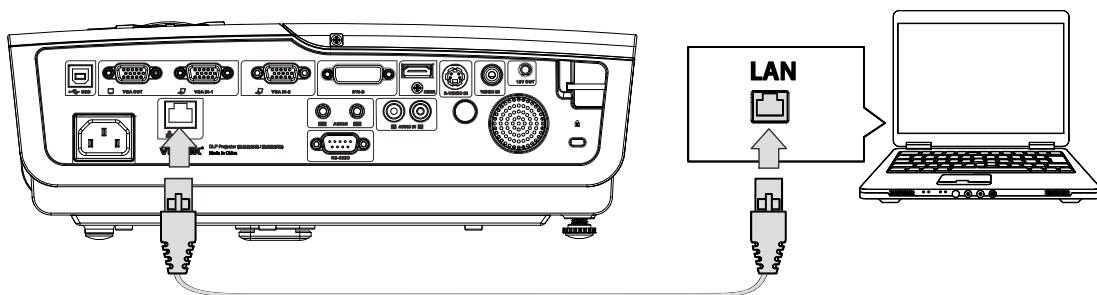

2. On the PC (Laptop), select **Start** → **Control Panel** → **Network Connections**.

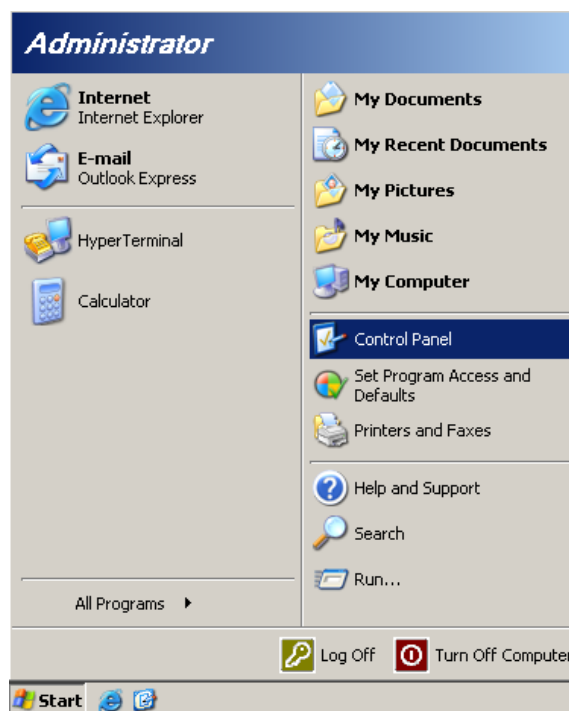

3. Right-click on **Local Area Connection**, and select **Properties**.

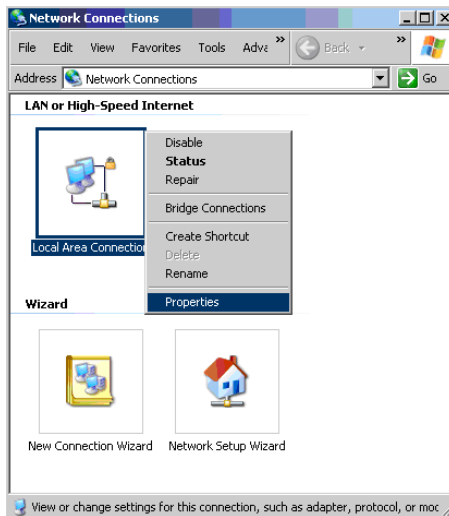

4. In the **Properties** window, select the **General** tab, and select **Internet Protocol (TCP/IP)**.
5. Click **Properties**.

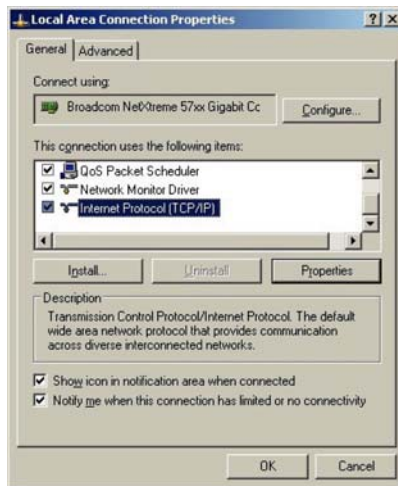

6. Click **Use the following IP address** and fill in the IP address and Subnet mask, then click **OK**.

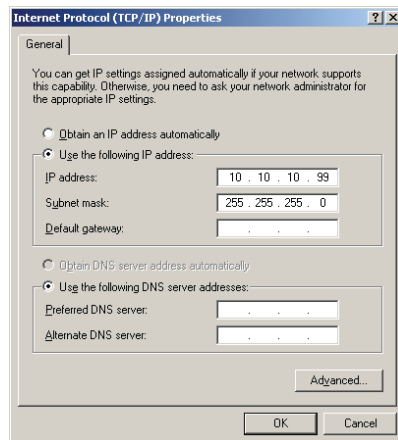

7. Press the **Menu** button on the projector.
8. Select **Advanced Setup** → **Network Settings** → **Control By** → **RJ45** option
9. After getting into **Network Status**, input the following:
 - ▶ DHCP: Off
 - ▶ IP Address: 10.10.10.10
 - ▶ Subnet Mask: 255.255.255.0
 - ▶ Gateway: 0.0.0.0
 - ▶ DNS Server: 0.0.0.0
10. Press **↵** (Enter) / **▶** to confirm settings.
Open a web browser
(for example, Microsoft Internet Explorer with Adobe Flash Player 9.0 or higher).

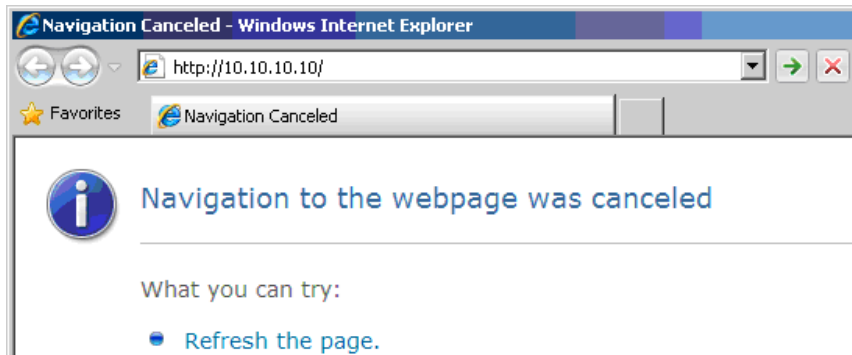

11. In the Address bar, input the IP address: 10.10.10.10.
12. Press **↵** (Enter) / **▶**.

The projector is setup for remote management. The LAN/RJ45 function displays as follows.



Expansion Options

CATEGORY	ITEM	INPUT-LENGTH
Crestron Control	IP Address	15
	IP ID	3
	Port	5
Projector	Projector Name	10
	Location	10
	Assigned To	10
Network Configuration	DHCP (Enabled)	(N/A)
	IP Address	15
	Subnet Mask	15
	Default Gateway	15
	DNS Server	15
User Password	Enabled	(N/A)
	New Password	10
	Confirm	10
Admin Password	Enabled	(N/A)
	New Password	10
	Confirm	10

For more information, please visit <http://www.crestron.com>.

RS232 by Telnet Function

Besides projector connected to RS232 interface with “Hyper-Terminal” communication by dedicated RS232 command control, there is alternative RS232 command control way, so called “RS232 by TELNET” for LAN/RJ45 interface.

Quick Start-Guide for “RS232 by TELNET”

Check and get the IP-Address on OSD of the projector.

Make sure that laptop/PC can access the web-page of the projector.

Make sure that “Windows Firewall” setting to be disabled in case of “TELNET” function filtering out by laptop/PC.



Start => All Programs => Accessories => Command Prompt

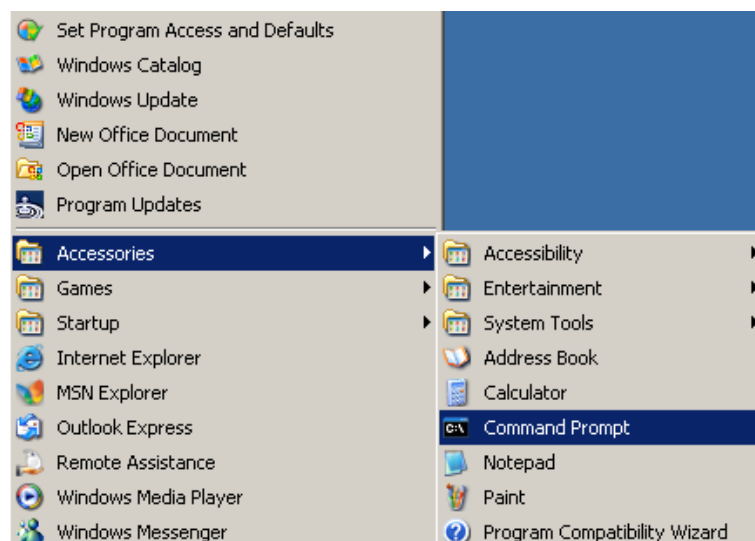

Input the command format like the below:

telnet ttt.xxx.yyy.zzz 23 (“Enter” key pressed)

(**ttt.xxx.yyy.zzz**: IP-Address of the projector)

If Telnet-Connection ready, and user can have RS232 command input, then “Enter” key pressed, the RS232 command will be workable.

How to have TELNET enabled in Windows VISTA / 7

By default installation for Windows VISTA, “TELNET” function is not included. But end-user can have it by way of “Turn Windows features On or Off” to be enabled.

Open “Control Panel” in Windows VISTA

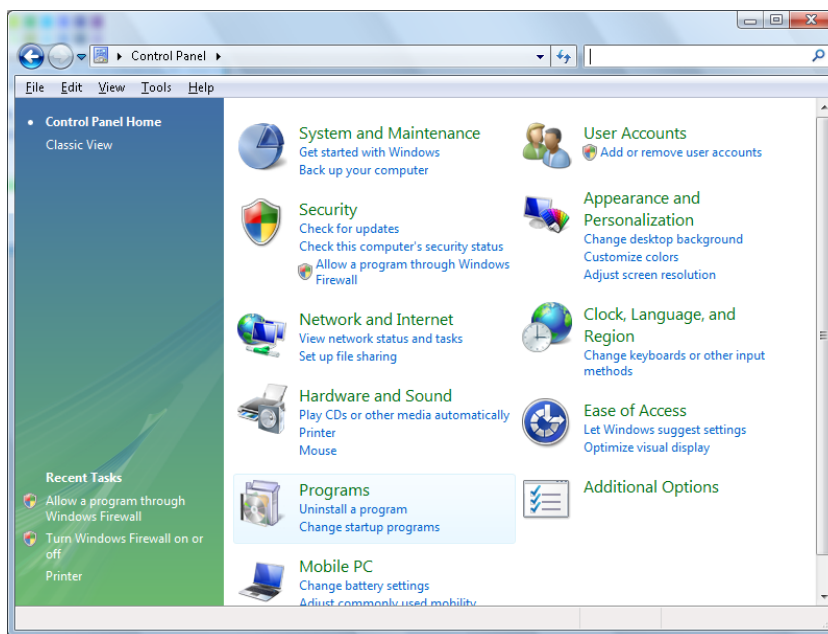

Open “Programs”

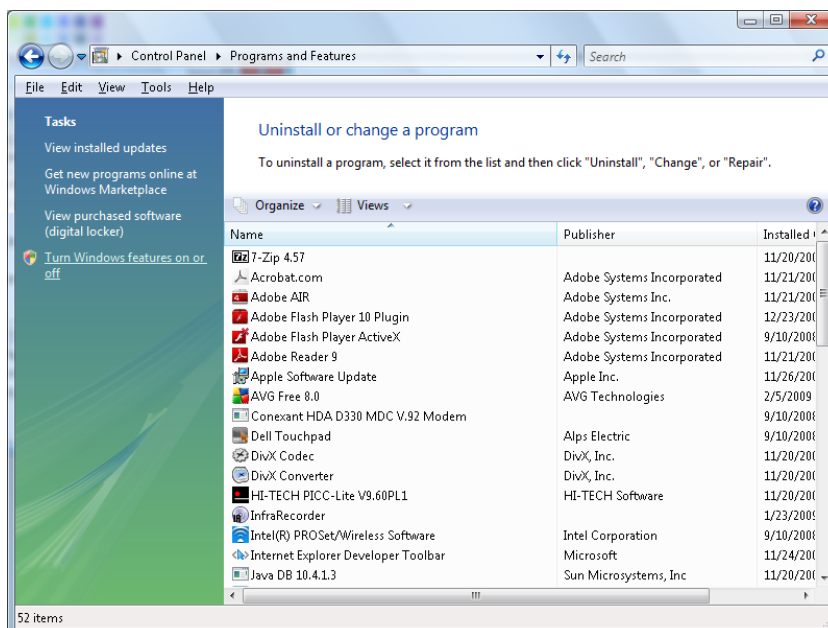

Select “Turn Windows features on or off” to open

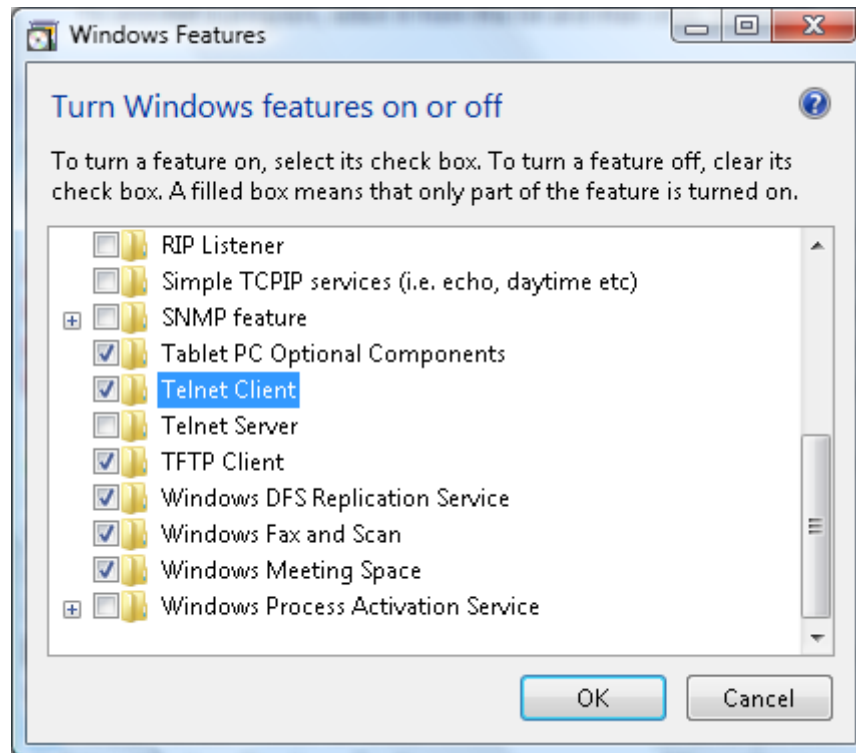

Have “Telnet Client” option checked, then press “OK” button.

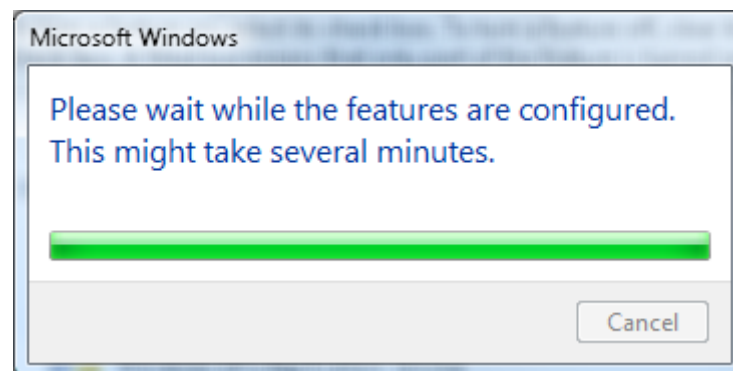

Specsheet for “RS232 by TELNET” :

- 1. Telnet: TCP
- 2. Telnet port: 8000
- 3. Telnet utility: Windows “TELNET.exe” (console mode)
- 4. Disconnection for RS232-by-Telnet control normally: Close Windows Telnet utility directly after TELNET connection ready
- 5. Limitation 1 for Telnet-Control: there is only one connection for Telnet-Control in one projector
Limitation 2 for Telnet-Control: there is less than 50 bytes for successive network payload for Telnet-Control application.

Limitation 3 for Telnet-Control: there is less than 26 bytes for one complete RS232 command for Telnet-Control.

Limitation 4 for Telnet-Control: Minimum delay for next RS232 command must be more than 200 (ms).

(*, In Windows XP built-in “TELNET.exe” utility, “Enter” key pressed will have “Carriage-Return” and “New-Line” code.)

- 6. The IP-Address setting/modification on OSD would be ‘tempo-DISABLED’, while RS232-by-Telnet connected running.
- 7. There is either/or option concerned for the RS232-by-Telnet, Crestron RoomView-Connected functions.
- 8. The Crestron RoomView-Connected is enabled by default. Once the RS232-by-Telnet enabled, the Crestron RoomView-Connected and IP-Address changing(re-configuration) function would be disabled silently.
- 9. Once the RS232-by-Telnet disconnected normally, the Crestron RoomView-Connected would be re-start in 5 seconds for control of manual re-connection in LAN.
- 10. Before the RS232-by-Telnet connection running, kindly please have the IP Address field to be “0.0.0.0” setting of “Crestron Control” in the Crestron web-FLASH UI to ease the bulky massive Crestron-Type packets.

Crestron Control	Projector	User Password
IP Address: 0.0.0.0	Projector Name: ABC	<input type="checkbox"/> Enabled
IP ID: 03	Location: room1	New Password: <input type="text"/>
Port: 41794	Assigned To: Sir.11	Confirm: <input type="text"/>
<input type="button" value="Send"/>	<input type="button" value="Send"/>	<input type="button" value="Send"/>
	DHCP: <input checked="" type="checkbox"/> Enabled	
	IP Address: 192.168.0.100	
	Subnet Mask: 255.255.255.0	
	Default Gateway: 192.168.0.254	
	DNS Server: 192.168.0.254	
	<input type="button" value="Send"/>	
		Admin Password
		<input type="checkbox"/> Enabled
		New Password: <input type="text"/>
		Confirm: <input type="text"/>
		<input type="button" value="Send"/>
		<input type="button" value="Send"/>



Factory Reset

Press the cursor ▲▼ button to move up and down in the **Installation II** menu. Select the **Factory Reset** sub menu and press ← (Enter) / ► to reset all the menu items to the factory default values (expect Language and Security Lock).

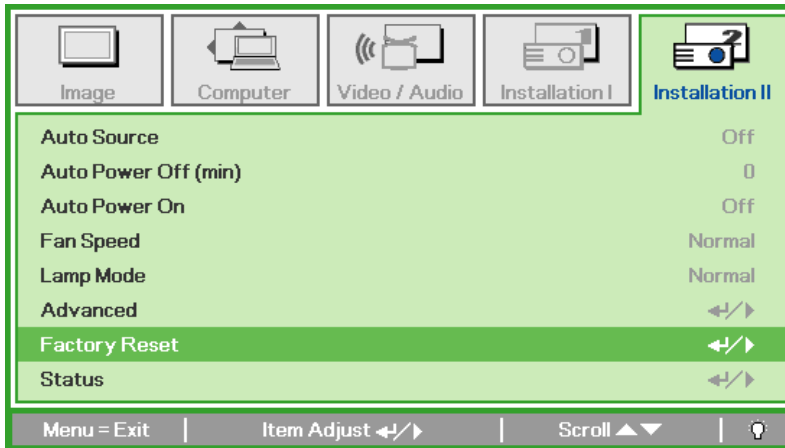

Status

Press the cursor ▲▼ button to move up and down in the **Installation II** menu. Select the **Installation II** sub menu and press ← (Enter) / ► to enter the **Status** sub menu.

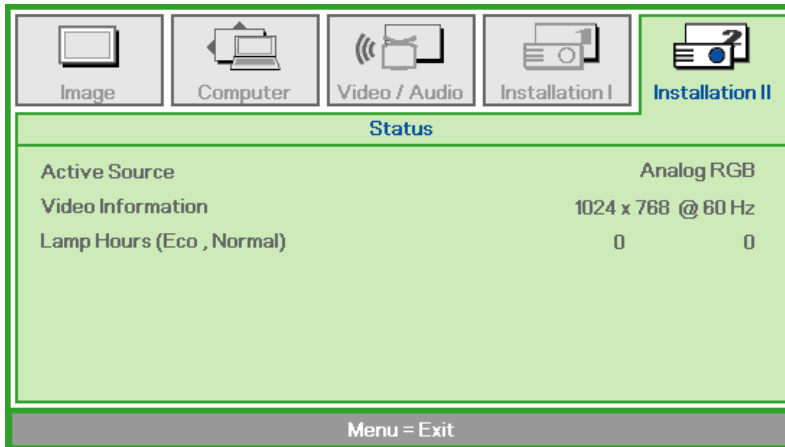

ITEM	DESCRIPTION
Active Source	Display the activated source.
Video Information	Displays resolution/video information for RGB source and color standard for Video source.
Lamp Hours	Lamp hour used information is displayed. Eco and Normal counters are separated.

MAINTENANCE AND SECURITY

Replacing the Projection Lamp

The projection lamp should be replaced when it burns out. It should only be replaced with a certified replacement part, which you can order from your local dealer.

Important:

- a. The projection lamp used in this product contains a small amount of mercury.
- b. Do not dispose this product with general household waste.
- c. Disposal of this product must be carried out in accordance with the regulations of your local authority.

Warning:

Be sure to turn off and unplug the projector at least 30 minutes before replacing the lamp. Failure to do so could result in a severe burn.

Caution:

In rare cases the lamp bulb may burn out during normal operation and cause glass dust or shards to be discharged outward from the rear exhaust vent.

Do not inhale or do not touch glass dust or shards. Doing so could result in injury.

Always keep your face away from the exhaust vent so that you do not suffer from the gas and broken shards of the lamp.

When removing the lamp from a ceiling-mounted projector, make sure that no one is under the projector. Glass fragments could fall if the lamp has been burned out.



IF A LAMP EXPLODES

If a lamp explodes, the gas and broken shards may scatter inside the projector and they may come out of the exhaust vent. The gas contains toxic mercury.

Open windows and doors for ventilation.

If you inhale the gas or the shards of the broken lamp enter your eyes or mouth, consult the doctor immediately.

1. Remove the single screw on the lamp compartment cover.

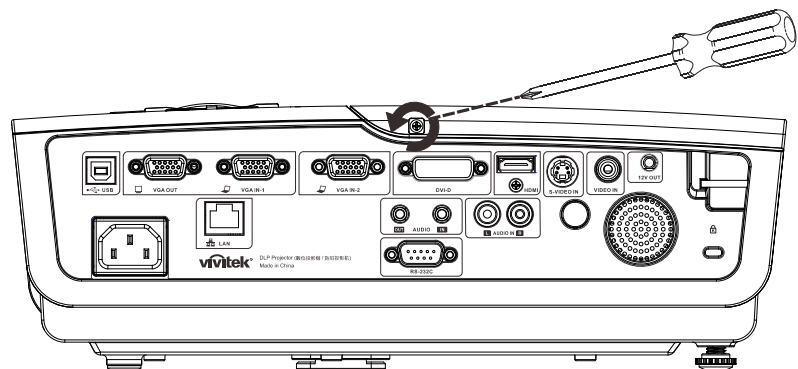

2. Remove the lamp compartment cover.

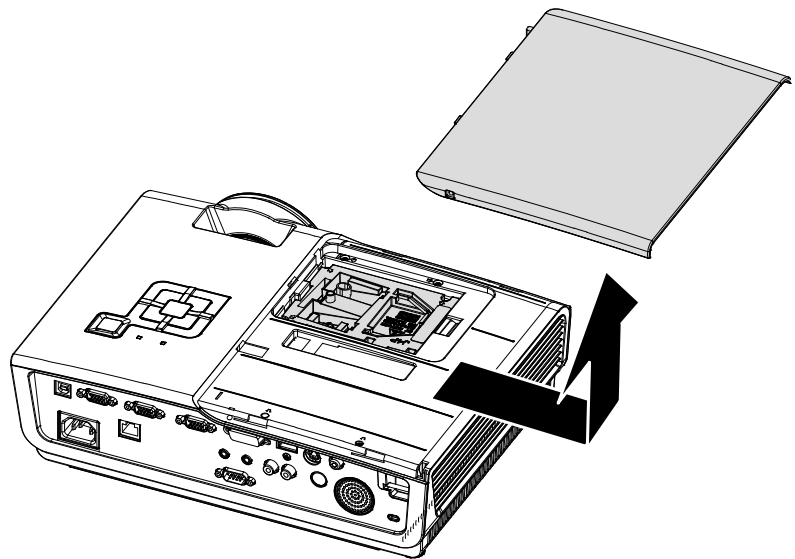

3. Remove the three screws from the lamp module.

4. Lift the module handle up.

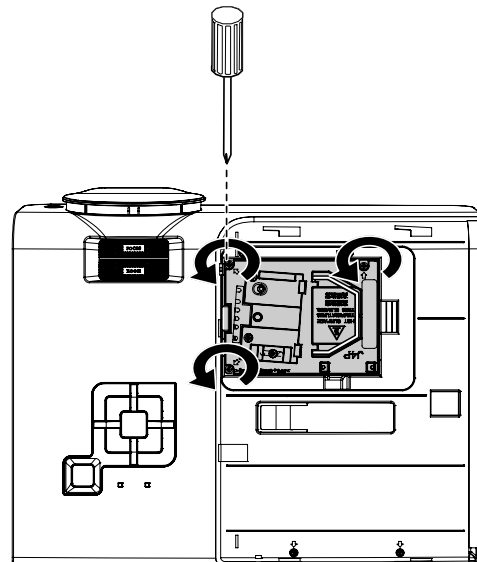

5. Pull firmly on the module handle to remove the lamp module.

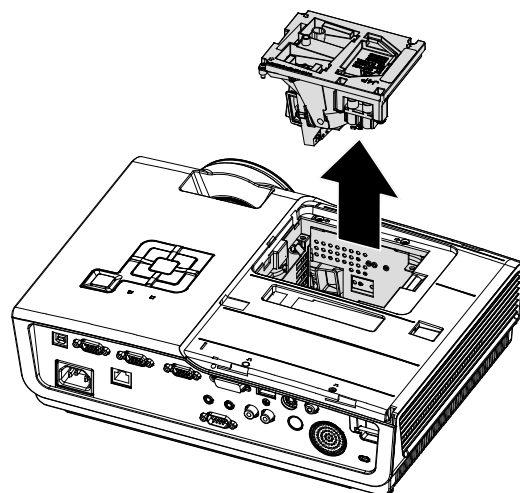

6. Reverse steps 1 to 5 to install the new lamp module. While installing, align the lamp module with the connector and ensure it is level to avoid damage.

Note: The lamp module must sit securely in place and the lamp connector must be connected properly before tightening the screws.

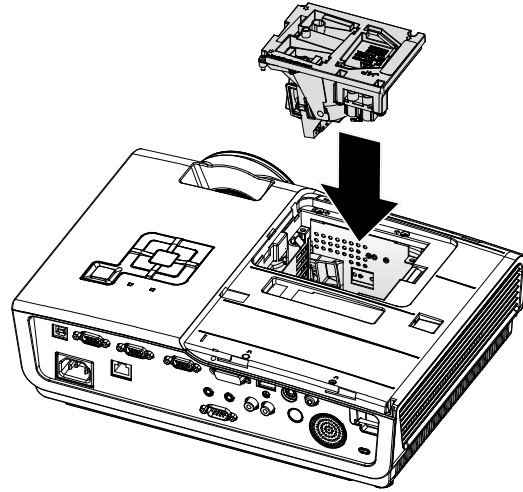

Resetting the Lamp

After replacing the lamp, you should reset the lamp hour counter to zero. Refer to the following:

1. Press the **MENU** button to open the OSD menu.
2. Press the cursor ◀▶ button to move to the **Installation II** menu. Press the cursor button to move down to **Advanced**.

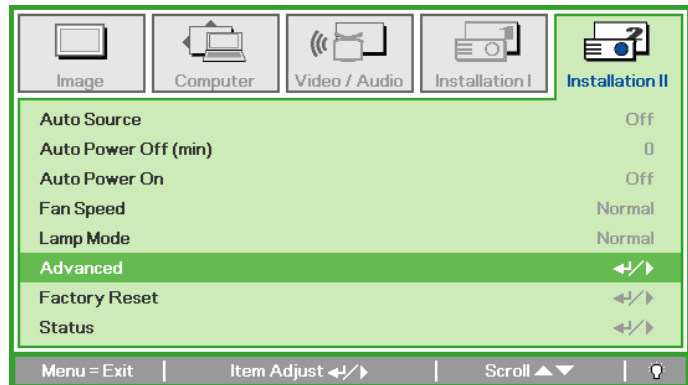

3. Press the cursor ▼▲ button to move down to **Lamp Hour Reset**.

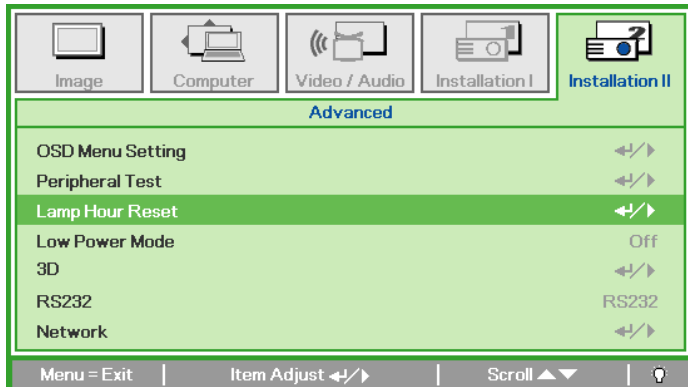

4. Press the cursor ▶ or Enter button.

A message screen appears.

5. Press ▼▲◀▶ buttons to reset the lamp hour.

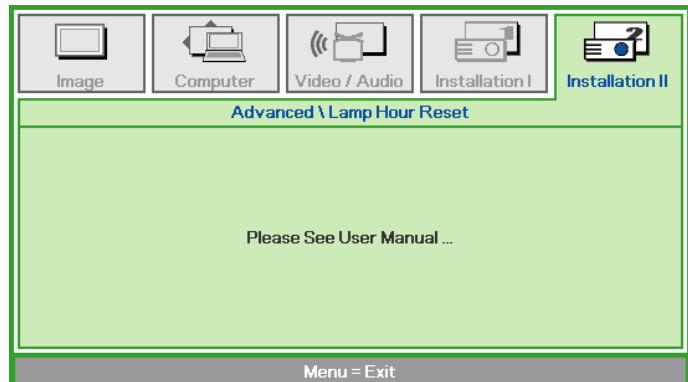

6. Press the **MENU** button to get back to Installation II.

Cleaning the Projector

Cleaning the projector to remove dust and grime will help ensure trouble-free operation.

Warning:

1. Be sure to turn off and unplug the projector at least 30 minutes before cleaning. Failure to do so could result in a severe burn.
2. Use only a dampened cloth when cleaning. Do not allow water to enter the ventilation openings on the projector.
3. If a little water gets into the projector interior while cleaning, leave unplugged in a well-ventilated room for several hours before using.
4. If a lot of water gets into the projector interior when cleaning, have the projector serviced.

Cleaning the Lens

You can purchase optic lens cleaner from most camera stores. Refer to the following to clean the projector lens.

1. Apply a little optic lens cleaner to a clean soft cloth. (Do not apply the cleaner directly to the lens.)
2. Lightly wipe the lens in a circular motion.

Caution:

1. Do not use abrasive cleaners or solvents.
2. To prevent discoloration or fading, avoid getting cleaner on the projector case.

Cleaning the Case

Refer to the following to clean the projector case.

1. Wipe off dust with a clean dampened cloth.
2. Moisten the cloth with warm water and mild detergent (such as used to wash dishes), and then wipe the case.
3. Rinse all detergent from the cloth and wipe the projector again.

Caution:

To prevent discoloration or fading of the case, do not use abrasive alcohol-based cleaners.

Using the Kensington® Lock & Using the Security Bar

If you are concerned about security, attach the projector to a permanent object with the Kensington slot and a security cable.

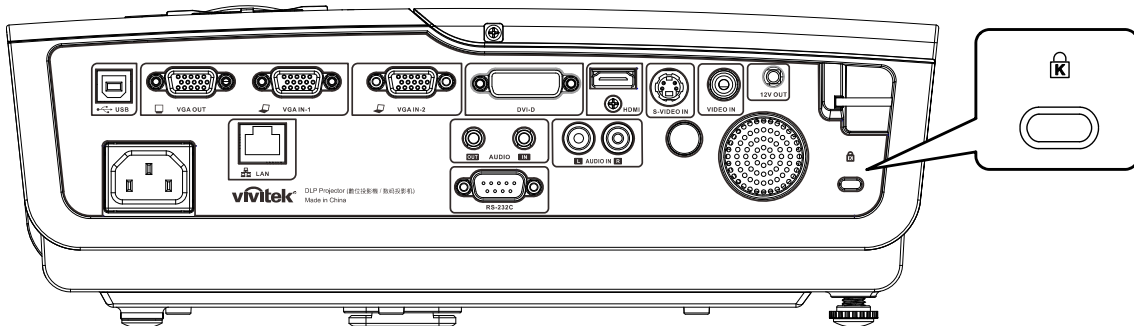
**Note:**

Contact your vendor for details on purchasing a suitable Kensington security cable.

The security lock corresponds to Kensington's MicroSaver Security System. If you have any comment, contact: Kensington, 2853 Campus Drive, San Mateo, CA 94403, U.S.A. Tel: 800-535-4242, <http://www.Kensington.com>.

Using the Security Bar

In addition to the password protection function and the Kensington lock, the Security Bar helps protect the projector from unauthorized removal. See the following picture.

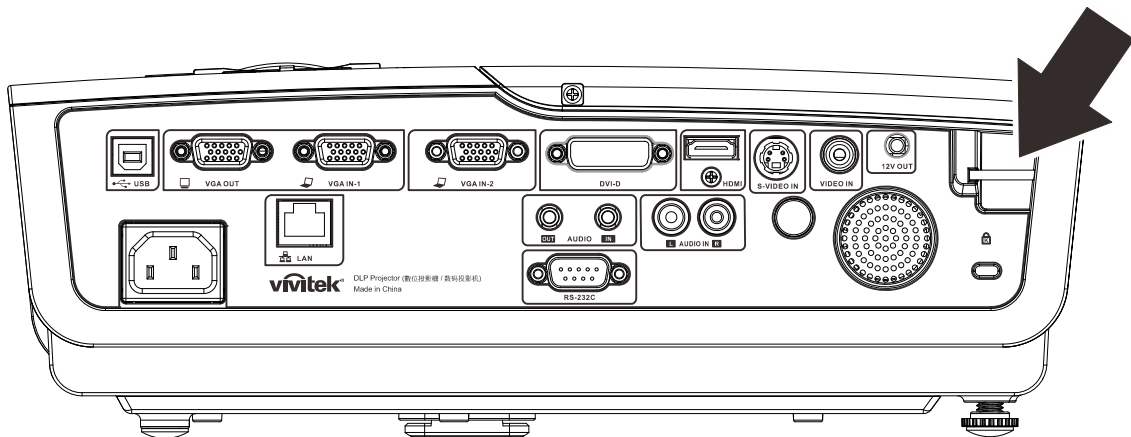

Common problems and solutions

These guidelines provide tips to deal with problems you may encounter while using the projector. If the problem remains unsolved, contact your dealer for assistance.

Often after time spent troubleshooting, the problem is traced to something as simple as a loose connection. Check the following before proceeding to the problem-specific solutions.

- *Use some other electrical device to confirm that the electrical outlet is working.*
- *Ensure the projector is turned on.*
- *Ensure all connections are securely attached.*
- *Ensure the attached device is turned on.*
- *Ensure a connected PC is not in suspending mode.*
- *Ensure a connected notebook computer is configured for an external display. (This is usually done by pressing a Fn-key combination on the notebook).*

Tips for Troubleshooting

In each problem-specific section, try the steps in the order suggested. This may help you to solve the problem more quickly.

Try to pin point the problem and thus avoid replacing non-defective parts.

For example, if you replace batteries and the problem remains, put the original batteries back and go to the next step.

Keep a record of the steps you take when troubleshooting: The information may be useful when calling for technical support or for passing on to service personnel.

LED Error Messages

ERROR CODE MESSAGES	POWER LED BLINK	READY LED BLINK	TEMP LED BLINK
Over temperature	OFF	OFF	ON
G794 fail	4	4	OFF
T1 fail	4	5	OFF
Lamp error	5	OFF	OFF
Fan1 error (Burner Fan)	6	1	OFF
Fan2 error (Lamp Fan)	6	2	OFF
Fan3 error (Power Fan)	6	3	OFF
Fan4 error (DMD Fan)	6	4	OFF
Lamp door open	7	OFF	OFF
DMD error	8	OFF	OFF
Color wheel error	9	OFF	OFF
Ballast error	10	OFF	OFF
Ballast communication error	10	1	OFF

In the event of an error, please disconnect the AC power cord and wait for one (1) minute before re-starting the projector. If the POWER or RESDY LEDs are still blinking or the TEMP LED is lit, contact your service center.

Image Problems

Problem: No image appears on the screen

1. Verify the settings on your notebook or desktop PC.
2. Turn off all equipment and power up again in the correct order.

Problem: The image is blurred

1. Adjust the **Focus** on the projector.
2. Press the **Auto** button on the remote control or projector.
3. Ensure the projector-to-screen distance is within the 10-meter (33-feet) specified range.
4. Check that the projector lens is clean.

Problem: The image is wider at the top or bottom (trapezoid effect)

1. Position the projector so it is as perpendicular to the screen as possible.
2. Use the **Keystone** button on the remote control or projector to correct the problem.

Problem: The image is reversed

Check the **Projection** setting on the **Installation I** menu of the OSD.

Problem: The image is streaked

1. Set the **Frequency** and **Tracking** settings on the **Computer** menu of the OSD to the default settings.
2. To ensure the problem is not caused by a connected PC's video card, connect to another computer.

Problem: The image is flat with no contrast

Adjust the **Contrast** setting on the **Image** menu of the OSD.

Problem: The color of the projected image does not match the source image.

Adjust the **Color Temperature** and **Gamma** settings on the **Image** menu of the OSD.

Lamp Problems

Problem: There is no light from the projector

1. Check that the power cable is securely connected.
2. Ensure the power source is good by testing with another electrical device.
3. Restart the projector in the correct order and check that the Power LED is green.
4. If you have replaced the lamp recently, try resetting the lamp connections.
5. Replace the lamp module.
6. Put the old lamp back in the projector and have the projector serviced.

Problem: The lamp goes off

1. Power surges can cause the lamp to turn off. Re-plug power cord. When the READY LED is on, press the power button.
2. Replace the lamp module.
3. Put the old lamp back in the projector and have the projector serviced.

Remote Control Problems

Problem: The projector does not respond to the remote control

1. Direct the remote control towards remote sensor on the projector.
2. Ensure the path between remote and sensor is not obstructed.
3. Turn off any fluorescent lights in the room.
4. Check the battery polarity.
5. Replace the batteries.
6. Turn off other Infrared-enabled devices in the vicinity.
7. Have the remote control serviced.

Audio Problems

Problem: There is no sound

1. Adjust the volume on the remote control.
2. Adjust the volume of the audio source.
3. Check the audio cable connection.
4. Test the source audio output with other speakers.
5. Have the projector serviced.

Problem: The sound is distorted

1. Check the audio cable connection.
2. Test the source audio output with other speakers.
3. Have the projector serviced.

Having the Projector Serviced

If you are unable to solve the problem, you should have the projector serviced. Pack the projector in the original carton. Include a description of the problem and a checklist of the steps you took when trying to fix the problem: The information may be useful to service personnel. For servicing, return the projector to the place you purchased it.

SPECIFICATIONS

Specifications

Model	D965
Display type	TI DMD 0.7" XGA
Native Resolution	XGA 1024x768
Weight	3.75 kg (8.27 lbs)
Projection distance	1 meters ~ 10 meters
Projection screen	23.4"~300"
Projection lens	Manual Focus/Manual Zoom
Zoom ratio	1.15
Vertical keystone	+/- 15 degrees, 40 steps
Projection methods	Front, Rear, Desktop/Ceiling (Rear, Front)
Data compatibility	VGA, SVGA, XGA, SXGA, UXGA, Mac
SDTV/EDTV/ HDTV	480i, 576i, 480p, 576p, 720p, 1080i, 1080p
Video compatibility	NTSC/NTSC 4.43, PAL (B/G/H/I/M/N/60), SECAM
H-Sync	15, 31 – 90 kHz
V-Sync	50 – 85 Hz
Safety certification	FCC-B, UL, cUL, CB, CE, CCC, KC, PCT, PSB, ICES-003 (Canada), C-tick, SASO, CECP, TW ECO Label
Operation tempera-	5° ~ 35°C
Dimensions	335 mm (W) x 102 mm (H) x 256 mm (D)
AC Input	AC Universal 100 ~ 240, Typical @ 110VAC (100~240)/+/-10%
Power consumption	380W
Stand By	<1 watt
Lamp	300W
Audio speaker	3W mono speaker
Input Terminals	VGA x 2
	S-Video x 1
	Composite Video x 1
	HDMI x 1
	DVI x 1
	RCA stereo x 1
	Mini-jack stereo x 1
Output Terminals	VGA x 1 (Loop Thru only for VGA IN-1)
	Mini-jack stereo x 1
Control Terminals	RS-232C
	RJ45
	USB (type B) ; 12V trigger
Security	Kensington lock

Projection Distance vs. Projection Size

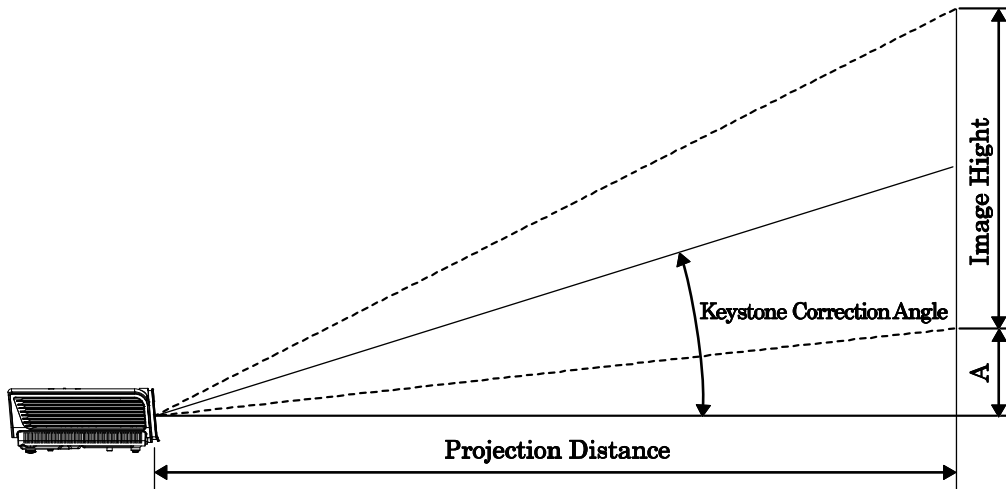

Projection Distance and Size Table

	TELE				WIDE			
Distance (m)	1.28	3.41	4.27	8.53	1.46	2.93	3.66	10.97
Diagonal (inches)	30	80	100	200	40	80	100	300
Keystone (degree)	12.55	12.55	12.55	12.55	14.56	14.56	14.56	14.56
Image Height (mm)	457.2	1219.2	1524	3048	609.6	1219.2	1524	4572
Image Width (mm)	609.6	1625.6	2032	4064	812.8	1625.6	2032	6096
A (mm)	56.4	150.5	188.1	376.3	75.3	150.5	188.1	564.4

Timing Mode Table

The projector can display several resolutions. The following table outlines the resolutions that can be displayed by the projector.

SIGNAL	RESOLUTION	H-SYNC (KHz)	V-SYNC (Hz)	COMPOSITE / S-VIDEO	COMPONENT	RGB (ANALOG)	DVI/ HDMI (DIGITAL)
NTSC	—	15.734	60.0	O	—	—	—
PAL/SECAM	—	15.625	50.0	O	—	—	—
VESA	720 x 400	37.9	85.0	—	—	O	O
	640 x 480	31.5	60.0	—	—	O	O
	640 x 480	37.9	72.8	—	—	O	O
	640 x 480	37.5	75.0	—	—	O	O
	640 x 480	43.3	85.0	—	—	O	O
	800 x 600	35.2	56.3	—	—	O	O
	800 x 600	37.9	60.3	—	—	O	O
	800 x 600	46.9	75.0	—	—	O	O
	800 x 600	48.1	72.2	—	—	O	O
	800 x 600	53.7	85.1	—	—	O	O
	1024 x 768	48.4	60.0	—	—	O	O
	1024 x 768	56.5	70.1	—	—	O	O
	1024 x 768	60.0	75.0	—	—	O	O
	1024 x 768	68.7	85.0	—	—	O	O
	1280 x 800	49.7	59.8	—	—	O	O
	1280 x 800	62.8	74.9	—	—	O	O
	1280 x 800	71.6	84.8	—	—	O	O
	1280 x 1024	64.0	60.0	—	—	O	O
	1280 x 1024	80.0	75.0	—	—	O	O
	1280 x 1024	91.1	85.0	—	—	O	O
1400 x 1050	65.3	60.0	—	—	O	O	
1440 x 900	55.9	60.0	—	—	O	O	
1600 x 1200	75.0	60	—	—	O	O	
Apple Macintosh	640 x 480	35.0	66.7	—	—	O	O
	832 x 624	49.7	74.5	—	—	O	O
	1024 x 768	60.2	74.9	—	—	O	O
	1152 x 870	68.7	75.1	—	—	O	O
SDTV	480i	15.734	60.0	—	O	—	O
	576i	15.625	50.0	—	O	—	O
EDTV	576p	31.3	50.0	—	O	—	O
	480p	31.5	60.0	—	O	—	O

SIGNAL	RESOLUTION	H-SYNC (KHz)	V-SYNC (Hz)	COMPOSITE / S-VIDEO	COMPONENT	RGB (ANALOG)	DVI/ HDMI (DIGITAL)
HDTV	720p	37.5	50.0	—	O	—	O
	720p	45.0	60.0	—	O	—	O
	1080i	33.8	60.0	—	O	—	O
	1080i	28.1	50.0	—	O	—	O
	1080p	67.5	60.0	—	O	—	O
	1080p	56.3	50.0	—	O	—	O

O: Frequency supported

—: Frequency not supported

Projector Dimensions

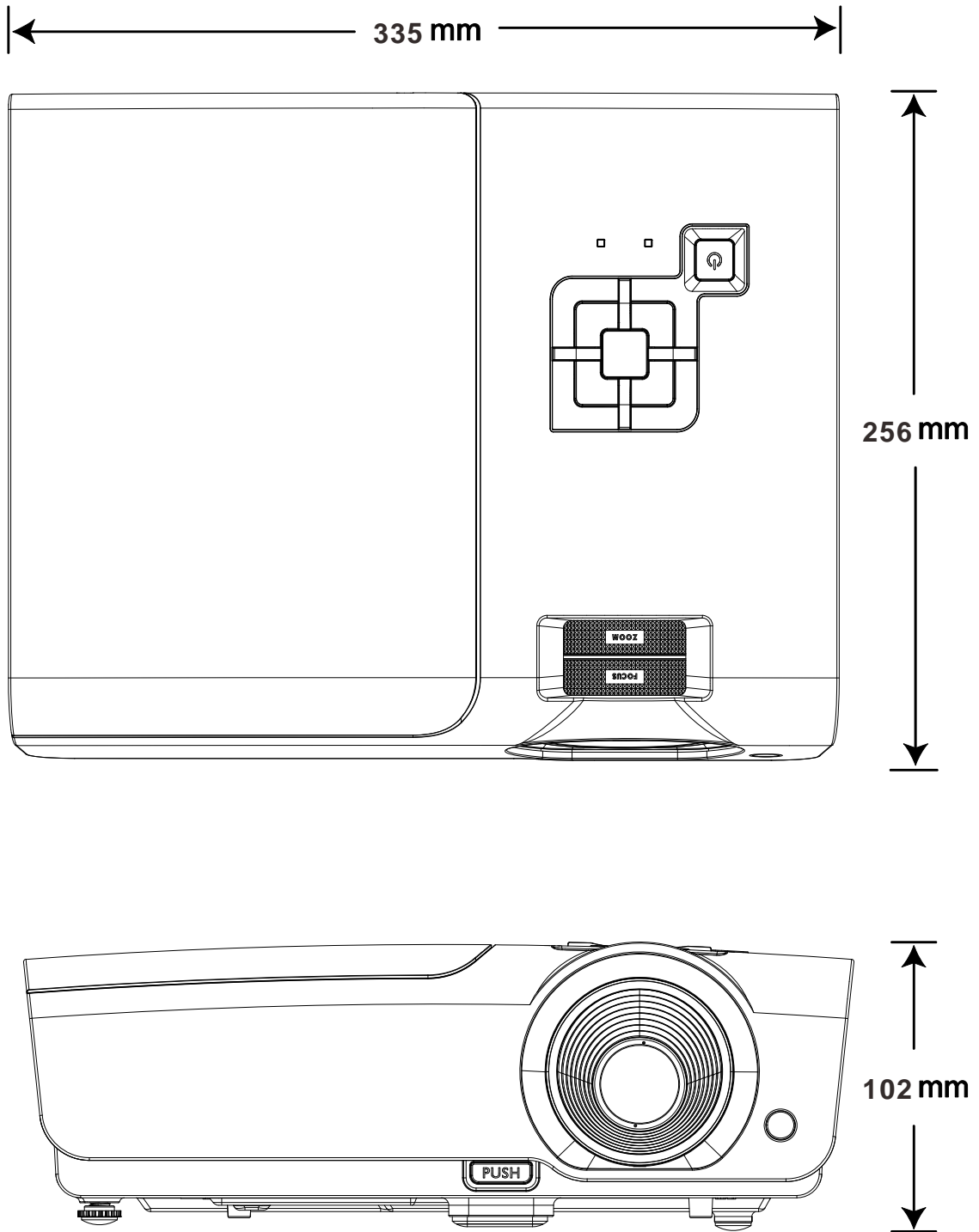

REGULATORY COMPLIANCE

FCC Warning

This equipment has been tested and found to comply with the limits for a Class B digital device pursuant to Part 15 of the FCC Rules. These limits are designed to provide reasonable protection against harmful interference when the equipment is operated in a commercial environment.

This equipment generates, uses, and can radiate radio frequency energy and, if not installed and used in accordance with the instruction manual, may cause harmful interference to radio communications. Operation of this equipment in a residential area is likely to cause harmful interference in which case the user will be required to correct the interference at his/her own expense.

Changes or modifications not expressly approved by the parties responsible for compliance could void the user's authority to operate the equipment.

Canada

This class B digital apparatus complies with Canadian ICES-003.

Safety Certifications

FCC-B, UL, cUL, CB, CE, CCC, KC, PCT, PSB, ICES-003 (Canada), C-tick, SASO, CECP and TW ECO Label

RS-232C Protocol

RS232 Setting

Baud rate:	9600
Parity check:	None
Data bit:	8
Stop bit:	1
Flow Control	None

Minimum delay for next command: **1ms**

Control Command Structure

	Header code	Command code	Data code	End code
HEX		Command	Data	0Dh
ASCII	'V'	Command	Data	CR

Operation Command

Note:
 XX=00-98, projector's ID, XX=99 is for all projectors
 Return Result P=Pass / F=Fail
 n: 0:Disable/1: Enable/Value(0~9999)

Command Group 00

ASCII	HEX	Function	Description	Return Result
VXXS0001	56h Xh Xh 53h 30h 30h 30h 31h 0Dh	Power On		P/F
VXXS0002	56h Xh Xh 53h 30h 30h 30h 32h 0Dh	Power Off		P/F
VXXS0003	56h Xh Xh 53h 30h 30h 30h 33h 0Dh	Resync		P/F
VXXG0004	56h Xh Xh 47h 30h 30h 30h 34h 0Dh	Get Lamp Hours		Pn/F
VXXS0006	56h Xh Xh 53h 30h 30h 30h 36h 0Dh	System Reset		P/F
VXXG0007	56h Xh Xh 47h 30h 30h 30h 37h 0Dh	Get System Status	0:Reset 1:Standby 2:Operation 3:Cooling	Pn/F
VXXG0008	56h Xh Xh 47h 30h 30h 30h 38h 0Dh	Get F/W Version		Pn/F

Command Group 01

ASCII	HEX	Function	Description	Return Value
VXXG0101	56h Xh Xh 47h 30h 31h 30h 31h 0Dh	Get Brightness	n=0~100	Pn/F
VXXS0101n	56h Xh Xh 53h 30h 31h 30h 31h nh 0Dh	Set Brightness	n=0~100	P/F

VXXG0102	56h Xh Xh 47h 30h 31h 30h 32h 0Dh	Get Contrast	n=0~100	Pn/F
VXXS0102n	56h Xh Xh 53h 30h 31h 30h 32h nh 0Dh	Set Contrast	n=0~100	P/F
VXXG0103	56h Xh Xh 47h 30h 31h 30h 33h 0Dh	Get Color	n=0~100	Pn/F
VXXS0103n	56h Xh Xh 53h 30h 31h 30h 33h nh 0Dh	Set Color	n=0~100	P/F
VXXG0104	56h Xh Xh 47h 30h 31h 30h 34h 0Dh	Get Tint	n=0~100	Pn/F
VXXS0104n	56h Xh Xh 53h 30h 31h 30h 34h nh 0Dh	Set Tint	n=0~100	P/F
VXXG0105	56h Xh Xh 47h 30h 31h 30h 35h 0Dh	Get Sharpness	0~31	Pn/F
VXXS0105n	56h Xh Xh 53h 30h 31h 30h 35h nh 0Dh	Set Sharpness	0~31	P/F
VXXG0106	56h Xh Xh 47h 30h 31h 30h 36h 0Dh	Get Color Temperature	0: Cold 1: Normal 2: Warm	Pn/F
VXXS0106n	56h Xh Xh 53h 30h 31h 30h 36h nh 0Dh	Set Color Temperature	0: Cold 1: Normal 2: Warm	P/F
VXXG0107	56h Xh Xh 47h 30h 31h 30h 37h 0Dh	Get Gamma	0: 1.0 1: 1.8 2: 2.0 3: 2.2 4: 2.35 5: 2.5	Pn/F
VXXS0107n	56h Xh Xh 53h 30h 31h 30h 37h nh 0Dh	Set Gamma	0: 1.0 1: 1.8 2: 2.0 3: 2.2 4: 2.35 5: 2.5	P/F

Command Group 02

ASCII	HEX	Function	Description	Return Value
VXXS0201	56h Xh Xh 53h 30h 32h 30h 31h 0Dh	Select RGB		P/F
VXXS0202	56h Xh Xh 53h 30h 32h 30h 32h 0Dh	Select RGB2		P/F
VXXS0203	56h Xh Xh 53h 30h 32h 30h 33h 0Dh	Select DVI		P/F
VXXS0204	56h Xh Xh 53h 30h 32h 30h 34h 0Dh	Select Video		P/F
VXXS0205	56h Xh Xh 53h 30h 32h 30h 35h 0Dh	Select S-Video		P/F
VXXS0206	56h Xh Xh 53h 30h 32h 30h 36h 0Dh	Select HDMI		P/F
VXXG0220	56h Xh Xh 47h 30h 32h 32h 30h 0Dh	Get Current Source	Return 1:RGB 2:RGB2 3:DVI 4:Video 5:S-Video 6:HDMI	Pn/F

Command Group 03				
ASCII	HEX	Function	Description	Return Value
VXXG0301	56h Xh Xh 47h 30h 33h 30h 31h 0Dh	Get Scaling	0: Fill 1: 4:3 2: 16:9 3 :Letter Box 4 :Native 5: 2.35:1	Pn/F
VXXS0301n	56h Xh Xh 53h 30h 33h 30h 31h nh 0Dh	Set Scaling	0: Fill 1: 4:3 2: 16:9 3 :Letter Box 4 :Native 5: 2.35:1	P/F
VXXG0302	56h Xh Xh 47h 30h 33h 30h 32h 0Dh	Blank		Pn/F
VXXS0302n	56h Xh Xh 53h 30h 33h 30h 32h nh 0Dh	Blank		P/F
VXXG0304	56h Xh Xh 47h 30h 33h 30h 34h 0Dh	Freeze On		Pn/F
VXXS0304n	56h Xh Xh 53h 30h 33h 30h 34h nh 0Dh	Freeze On		P/F
VXXG0305	56h Xh Xh 47h 30h 33h 30h 35h 0Dh	Volume	n=0~8	Pn/F
VXXS0305n	56h Xh Xh 53h 30h 33h 30h 35h nh 0Dh	Volume	n=0~8	P/F
VXXG0308	56h Xh Xh 47h 30h 33h 30h 38h 0Dh	Projection Mode	0:Front 1:Rear 2: Ceiling 3: Rear+Ceiling	Pn/F
VXXS0308n	56h Xh Xh 53h 30h 33h 30h 38h nh 0Dh	Projection Mode	0:Front 1:Rear 2: Ceiling 3: Rear+Ceiling	P/F
VXXG0309	56h Xh Xh 47h 30h 33h 30h 39h 0Dh	Set vertical key-stone value	n=-40~+40	Pn/F
VXXS0309n	56h Xh Xh 53h 30h 33h 30h 39h nh 0Dh	Set vertical key-stone value	n=-40~+40	P/F
VXXG0311	56h Xh Xh 47h 30h 33h 31h 31h 0Dh	Adjust the zoom	n=-10~+10	Pn/F
VXXS0311n	56h Xh Xh 53h 30h 33h 31h 31h nh 0Dh	Adjust the zoom	n=-10~+10	P/F

Command Group 04 (Remote Control)				
ASCII	HEX	Function	Description	Return Value
VXXS0401	56h Xh Xh 53h 30h 34h 30h 31h 0Dh	UP arrow		P/F
VXXS0402	56h Xh Xh 53h 30h 34h 30h 32h 0Dh	DOWN arrow		P/F
VXXS0403	56h Xh Xh 53h 30h 34h 30h 33h 0Dh	LEFT arrow		P/F
VXXS0404	56h Xh Xh 53h 30h 34h 30h 34h 0Dh	RIGHT arrow		P/F
VXXS0405	56h Xh Xh 53h 30h 34h 30h 35h 0Dh	POWER		P/F
VXXS0406	56h Xh Xh 53h 30h 34h 30h 36h 0Dh	EXIT		P/F
VXXS0407	56h Xh Xh 53h 30h 34h 30h 37h 0Dh	INPUT		P/F
VXXS0408	56h Xh Xh 53h 30h 34h 30h 38h 0Dh	AUTO		P/F
VXXS0409	56h Xh Xh 53h 30h 34h 30h 39h 0Dh	KEYSTONE+		P/F
VXXS0410	56h Xh Xh 53h 30h 34h 31h 30h 0Dh	KEYSTONE-		P/F
VXXS0411	56h Xh Xh 53h 30h 34h 31h 31h 0Dh	MENU		P/F
VXXS0412	56h Xh Xh 53h 30h 34h 31h 32h 0Dh	STATUS		P/F
VXXS0413	56h Xh Xh 53h 30h 34h 31h 33h 0Dh	MUTE		P/F
VXXS0414	56h Xh Xh 53h 30h 34h 31h 34h 0Dh	ZOOM+		P/F
VXXS0415	56h Xh Xh 53h 30h 34h 31h 35h 0Dh	ZOOM-		P/F
VXXS0416	56h Xh Xh 53h 30h 34h 31h 36h 0Dh	BLANK		P/F
VXXS0417	56h Xh Xh 53h 30h 34h 31h 37h 0Dh	FREEZE		P/F
VXXS0418	56h Xh Xh 53h 30h 34h 31h 38h 0Dh	VOLUME+		P/F
VXXS0419	56h Xh Xh 53h 30h 34h 31h 39h 0Dh	VOLUME-		P/F
VXXS0420	56h Xh Xh 53h 30h 34h 32h 30h 0Dh	Enter		P/F