

# QUMI

**User Manual**

用戶手冊

用戶手冊

**Manual del usuario**

**Manuel de l'utilisateur**

**Benutzerhandbuch**

사용자 설명서

**Руководство пользователя**

**Gebruikershandleiding**

**Instrukcja obsługi**

**Uživatelská příručka**

**Εγχειρίδιο χρήσης**

**Kullanım Kılavuzu**

**Manuale d'uso**

**Handbok**

**Brugervejledning**

**Brukerveiledning**

**Käyttöohje**

**Felhasználói kézikönyv**

مدخنتس مل ا ل ي ل د

**Manual do Usuário**

## Preface

### Copyright

©2011 Vivitek Corporation. **vivitek**<sup>®</sup> is a trademark of Vivitek Corporation. Other trademarks are the properties of their respective owners. Values, weights and dimensions are approximate. Specifications are subject to change without prior notice.

### Disclaimer

The information in this document is subject to change without notice. The manufacturer makes no representations or warranties with respect to the contents hereof and specifically disclaims any implied warranties of merchantability or fitness for any particular purpose. The manufacturer reserves the right to revise this publication and to make changes from time to time in the content hereof without obligation of the manufacturer to notify any person of such revision or changes.

### Trademark Recognition

HDMI, the HDMI Logo, and High-Definition Multimedia Interface are trademarks or registered trademarks of HDMI Licensing LLC in the United States and other countries.

All other product names used in this manual are the properties of their respective owners and are acknowledged.



## Important Safety Information

**Important:**

*It is strongly recommended that you read this section carefully before using the Qumi. These safety and usage instructions that will make sure you enjoy many years of safe use of the Qumi. Keep this manual for future reference.*

### Symbols Used

Warning symbols are used on the unit and in this manual to alert you of hazardous situations.

The following styles are used in this manual to alert you to important information.

**Note:**

*Provides additional information on the topic at hand.*

**Important:**

*Provides additional information that should not be overlooked.*

**Caution:**

*Alerts you to situations that may damage the unit.*

**Warning:**

*Alerts you to situations that may damage the unit, create a hazardous environment, or cause personal injury.*

Throughout this manual, component parts and items in the OSD (On-Screen Display) menus are denoted in bold font as in this example:

“Press the **Menu** button on the remote control to open the **Main** menu.”

### General Safety Information

- Do not open the unit case. There are no user-serviceable parts in the unit. For servicing, contact qualified service personnel.
- Follow all warnings and cautions in this manual and on the unit case.
- The projection light source is extremely bright by design. To avoid damage to eyes, do not look into the lens when the LED illumination is on.
- Do not place the unit on an unstable surface or stand.
- Avoid using the system near water, in direct sunlight, or near a heating device.
- Do not place heavy objects such as books or bags on the unit.



## Qumi Installation Notice

- Allow at least a 50cm clearance around the exhaust vent.

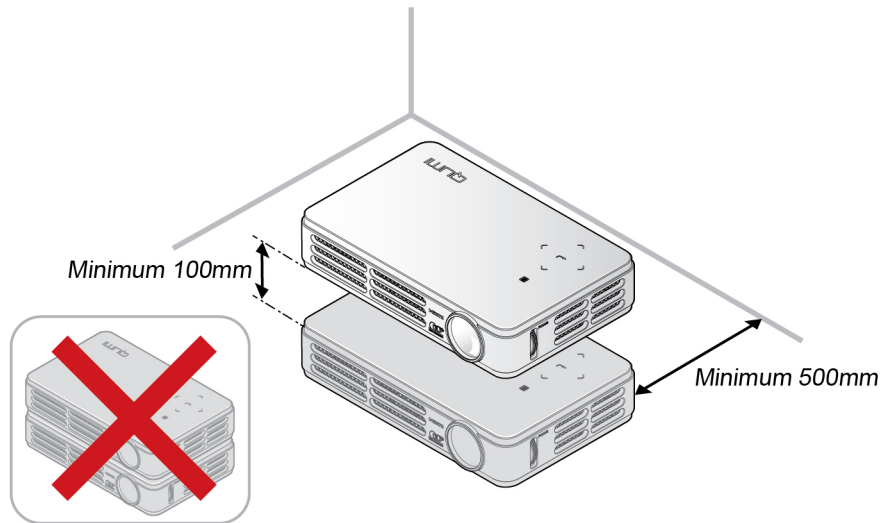

- Make sure that the intake vents do not recycle hot air from the exhaust vent.
- When operating the Qumi in an enclosed space, make sure that the surrounding air temperature within the enclosure does not exceed operating temperature while the Qumi is running, and the air intake and exhaust vents are unobstructed.
- All enclosures should pass a certified thermal evaluation to make sure that the Qumi does not recycle exhaust air, as this may cause the device to shutdown even if the enclosure temperature is with the acceptable operating temperature range.

**Caution:**

*Avoid using the Qumi in dusty environments.*



## Power Safety

- Only use the supplied adapter.
- Do not place anything on the cord. Place the cord where it will not be in the way of foot traffic.
- Remove the battery from the remote control when storing or not in use for a prolonged period.

## Cleaning the Qumi

- Unplug the cord before cleaning. See *Cleaning the Qumi* on page 36.

### **Note:**

*The Qumi will be warm after usage. Allow Qumi to cool down before storing in a compartment.*

## Regulatory Warnings

Before installing and using the Qumi, read the regulatory notices in the *Regulatory Compliance* on page 45.

## Symbol Explanations



**DISPOSAL:** Do not use household or municipal waste collection services for disposal of electrical and electronic equipment. EU countries require the use of separate recycling collection services.

## Main Features

- Lightweight unit, easy to pack away and transport.
- Compatible with all major video standards including NTSC, PAL, and SECAM.
- A high brightness rating allows for presentations in daylight or in lit rooms.
- Supports data resolution up to UXGA at 16.7 million colors to deliver crisp, clear images.
- Flexible setup allows for front, rear, ceiling and rear ceiling projections.
- Line-of-vision projections remain square, with advanced keystone correction for angled projections.
- Input source automatically detected.

## About this manual

This manual is intended for end users and describes how to install and operate the Qumi. Wherever possible, relevant information—such as an illustration and its description—has been kept on one page. This printer-friendly format is both for your convenience and to help save paper, thereby protecting the environment. It is suggested that you only print sections that are relevant to your needs.



# Table of Contents

Preface .....	ii
<b>Chapter 1 At a Glance .....</b>	<b>1</b>
Overview .....	1
Accessories.....	3
Remote Control.....	4
Qumi and Remote Control Buttons.....	4
Media Player Screen .....	4
<b>Chapter 2 Getting Started .....</b>	<b>5</b>
What You Need.....	5
Setting Up Qumi.....	6
Setting Up the Remote .....	12
<b>Chapter 3 Qumi Media Suite.....</b>	<b>13</b>
Overview.....	13
Movies.....	14
Photos.....	15
Music.....	16
Office Viewer .....	18
Settings.....	19
<b>Chapter 4 On-Screen Display (OSD) Settings.....</b>	<b>20</b>
OSD Menu Controls .....	20
Setting the OSD Language.....	21
OSD Menu Overview.....	22
OSD Sub-Menu Overview.....	23
Image Menu .....	24
Computer Menu.....	26
Video/Audio Menu.....	27
Installation I Menu .....	29
Installation II Menu .....	31
<b>Chapter 5 Taking Care of Your Qumi .....</b>	<b>36</b>
Cleaning the Qumi .....	36
Cleaning the Lens .....	36
Troubleshooting.....	37
Vivitek Support Site .....	40
Specifications .....	41
Projection Distance vs. Projection Size .....	42
Projection Distance and Size Table.....	42
Timing Mode Table.....	43
Qumi Dimensions .....	44
Regulatory Compliance.....	45
Safety Certifications .....	45
Disposal and Recycling .....	45



# Chapter 1 At a Glance

## Overview

### Front/Top/Right View

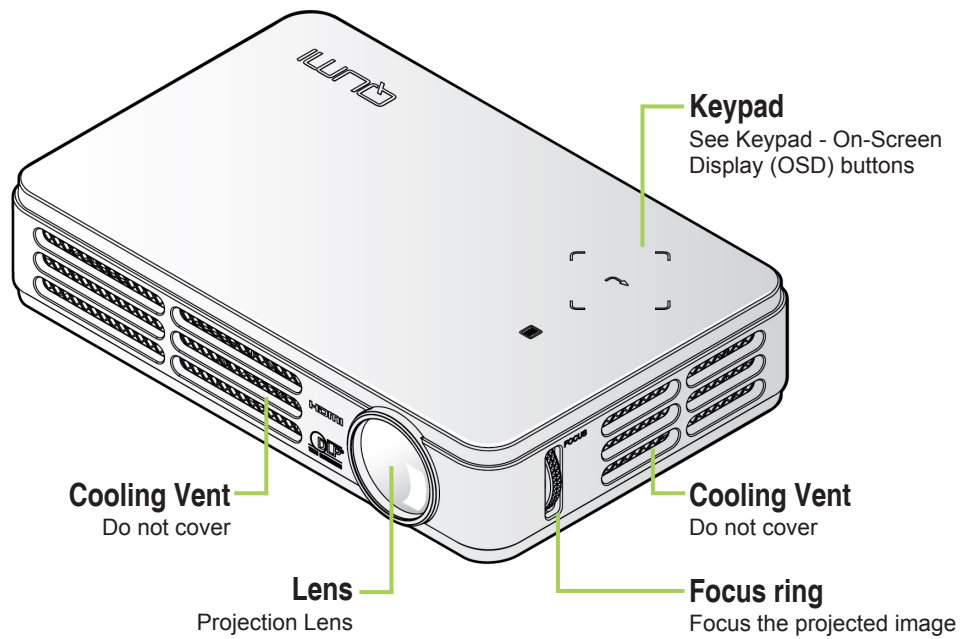

### Keypad

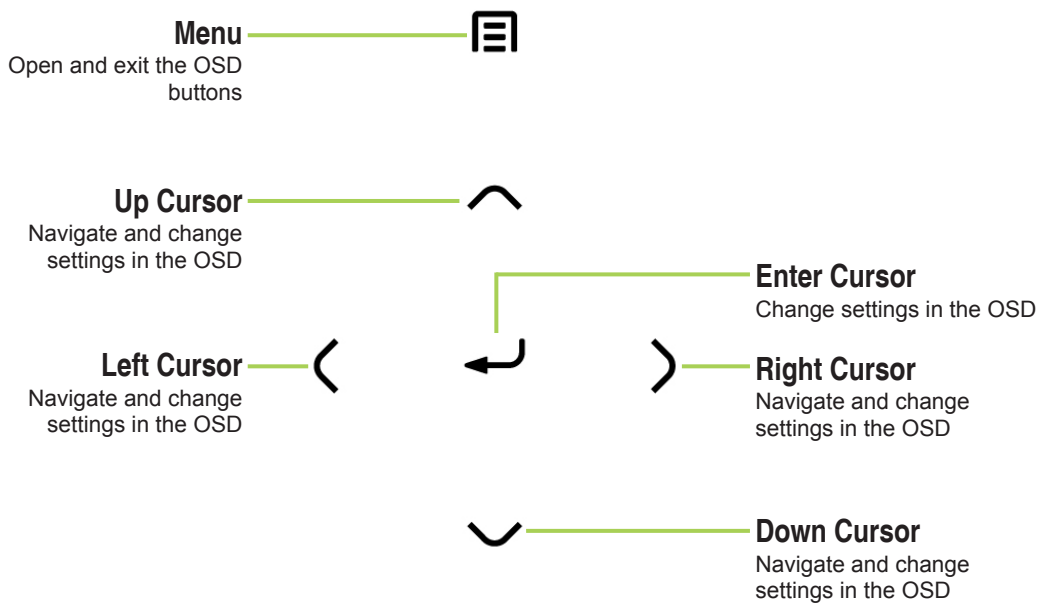

## Rear/Top/Left View

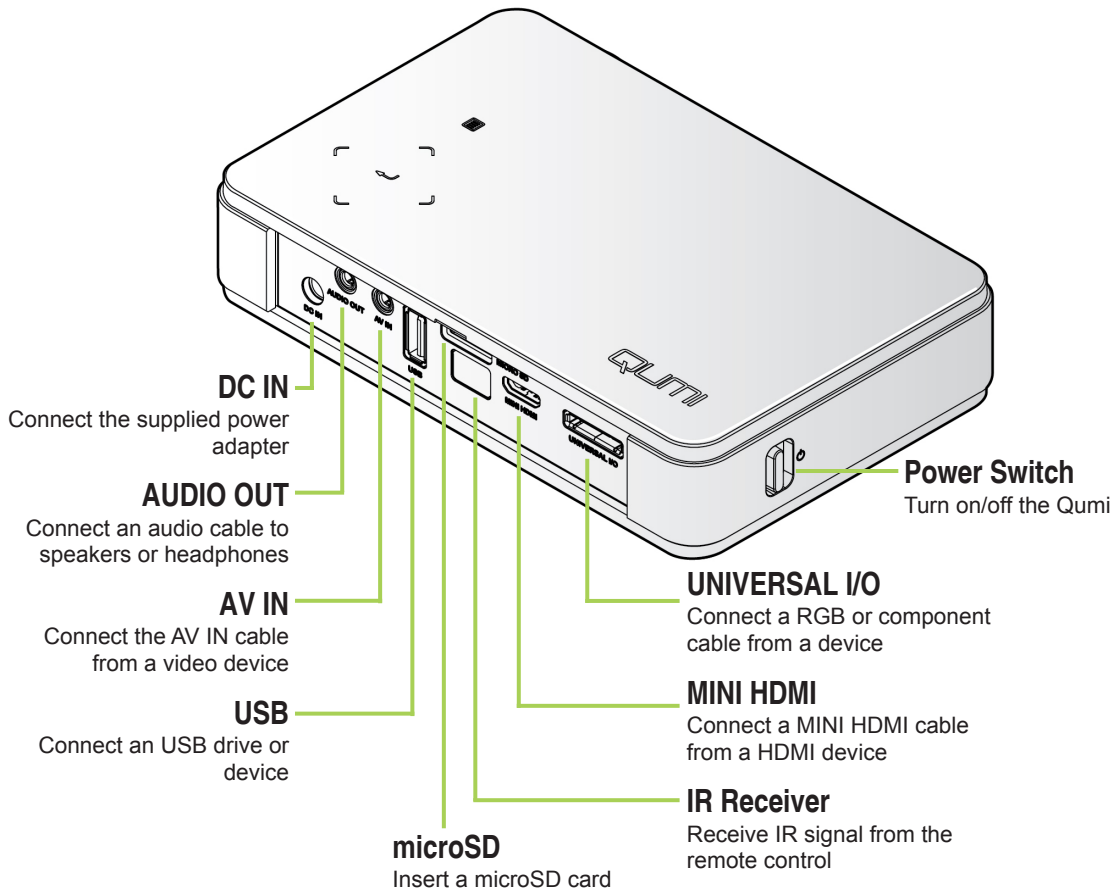

## Bottom View

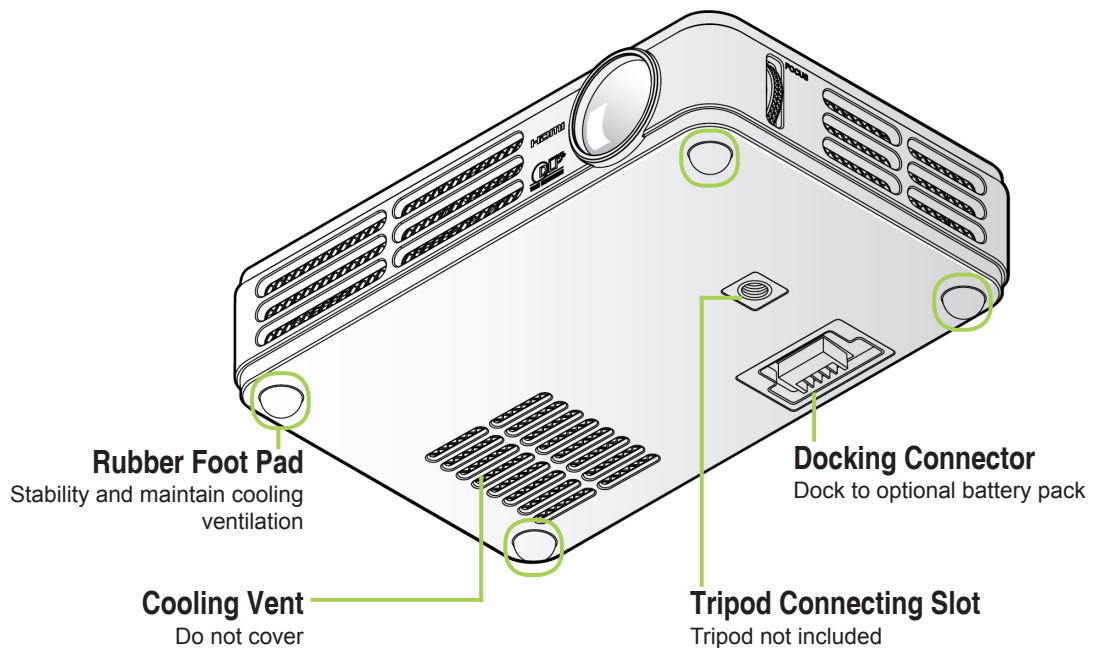



## Accessories

Along with the Qumi, the following accessories are included:



Remote Control  
(With one 3V CR2025 battery)



Mini to Standard HDMI Cable



Mini to Mini HDMI Cable



VGA Cable

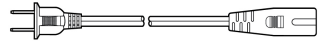

Regional Power Cord and Power Adapter

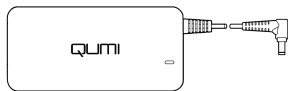

APPLE® Connection Kit

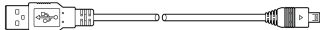
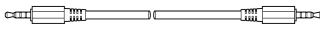

Documentation Kit  
(User Manual, Quick Start Guide, Warranty Card)

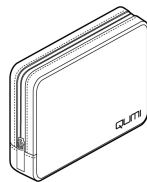

Carrying Case



Cable Cores (x2)\*

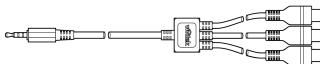

Audio/Video Cable (Optional)

Contact your dealer immediately if any items are missing, appear damaged, or if the unit does not work. It is recommended that you keep the original packing material should you ever need to return the equipment for warranty service.

### Note:

*Accessories will vary from model to model.*

*\* To ensure a high quality performance from your project and to prevent electromagnetic interference (EMI), equip the VGA or HDMI video source cable with the included cable cores.*



## Remote Control

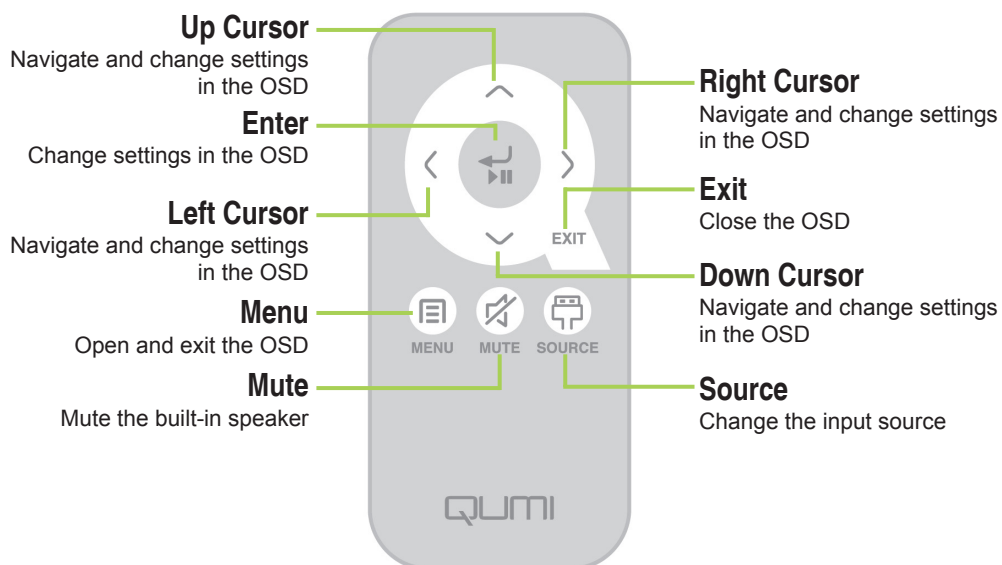

### **Important:**

1. Be sure nothing obstructs the path between the remote control and the Qumi. If the path between the remote control and the Qumi is obstructed, the signal can bounce off certain reflective surfaces.
2. The buttons and keys on the Qumi have the same layout and similar functions as the corresponding buttons on the remote control. This user's manual describes the functions based on the remote control.

## Qumi and Remote Control Buttons

The Qumi can be operated using the remote control or the keypad on the top of the Qumi. All operations can be carried out with the remote control; however, the keypad on the Qumi carries out the same operations as the remote control by pressing a combination of keys.

The remote control is not only used to navigate the cursor in the menus, but can also be used to control the media functions (music and video playback). For more details about how to control the media functions with the remote control, please refer to 13.

## Media Player Screen

The media player screen is the main interface for the Qumi Q2 Series. If a USB or MicroSD card is plugged in when powering on the Qumi, the media player screen appears. In the media player screen, you can choose the type of media to display by selecting:

- Movie – An easy to use movie player that displays multiple movie formats.
- Photo – A photo viewer that contains slide show functionality.
- Music – A music player that supports many types of audio files, ready to play music.
- Office viewer – A document viewer that displays documents.
- Settings – The settings of the Qumi can be adjusted in this menu.

## Chapter 2 Getting Started

### What You Need

Many types of external devices and peripherals can be connected to the Qumi. External or portable music players can be connected to play music. DVD, VCD and VHS players can be connected to play movies. Camcorders and digital cameras can also be used to play videos and display photos. Computers can be connected, as well as peripherals such as microSD cards and USB drives to display documents and other types of media.

These devices can be connected to the Qumi by using an appropriate cable. Make sure that the connecting device has an appropriate output connector.

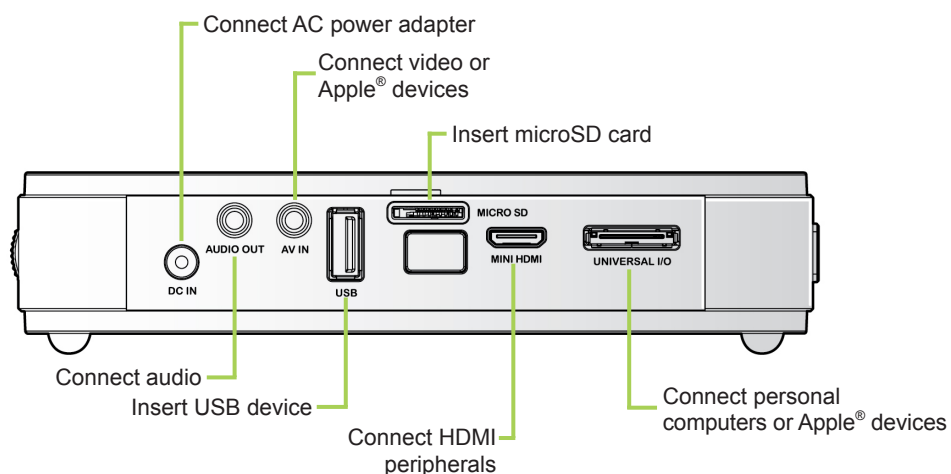

#### **Warning:**

As a safety precaution, disconnect all power to the Qumi and connecting devices before making connections.



## Setting Up Qumi

### Connecting Apple® Devices

Connect an Apple® device to the Qumi by using the following:

#### *Apple® Connection Kit*

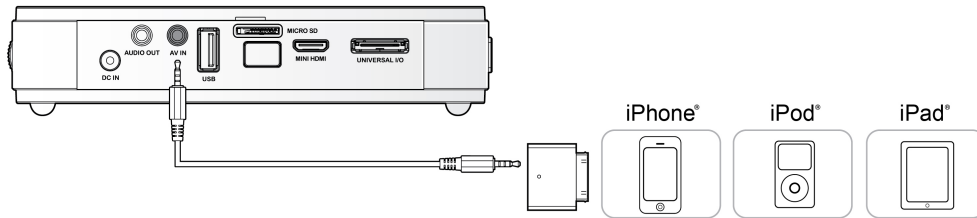

#### *VGA to Apple® Video Adapter (Optional)*

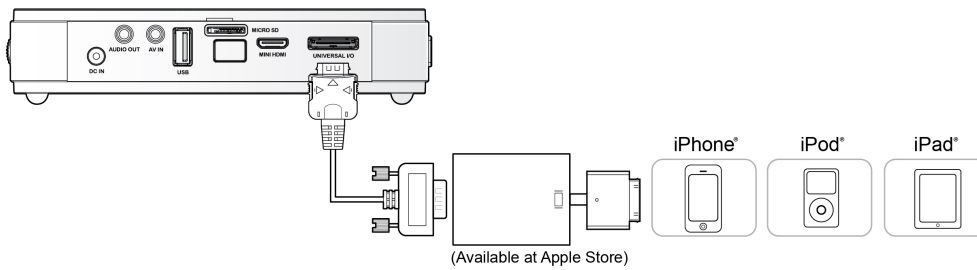

### Connecting Peripherals by HDMI

Connect HDMI-compatible peripherals to the Qumi using the Mini to Standard HDMI cable.

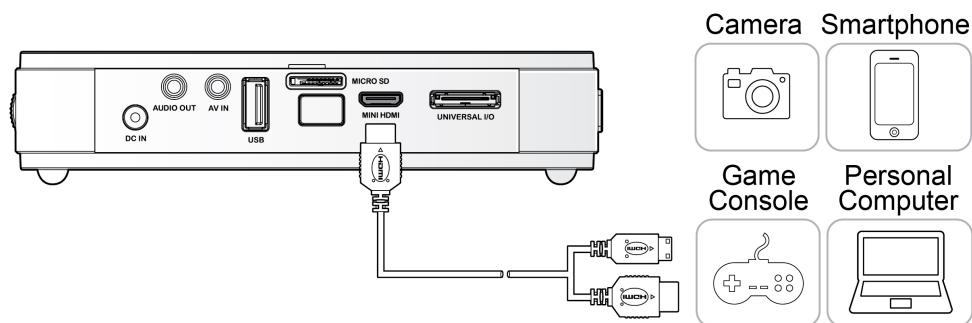

## Connecting Personal Computers

Connect a personal computer to the Qumi by using the VGA cable.

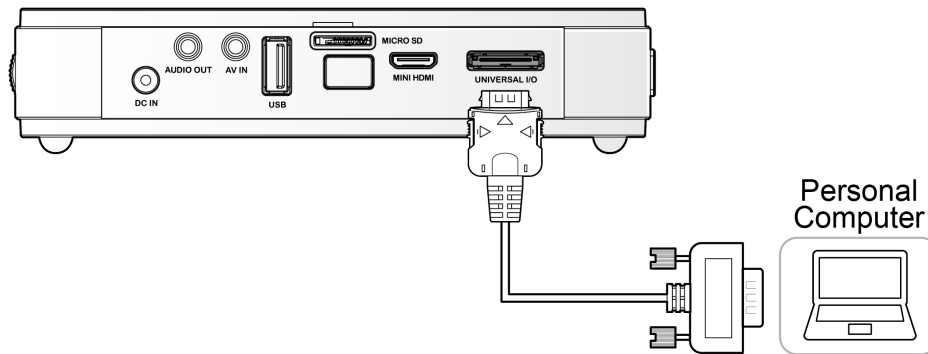

### **Note:**

The personal computer must have a VGA output port to use the VGA cable to connect to the Qumi.

## Inserting a microSD Card or USB Drive

Connect a USB drive or microSD card to the Qumi by inserting the storage device(s) into the appropriate port.

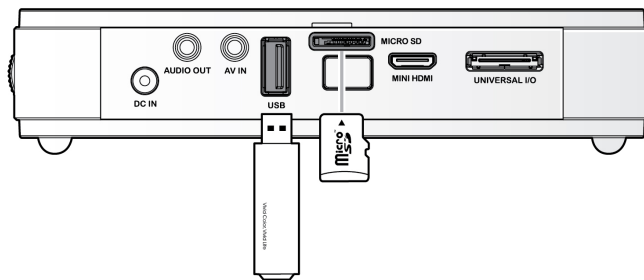

## Connecting Video

Connect video devices to the Qumi by using the audio/video cable (optional accessory).

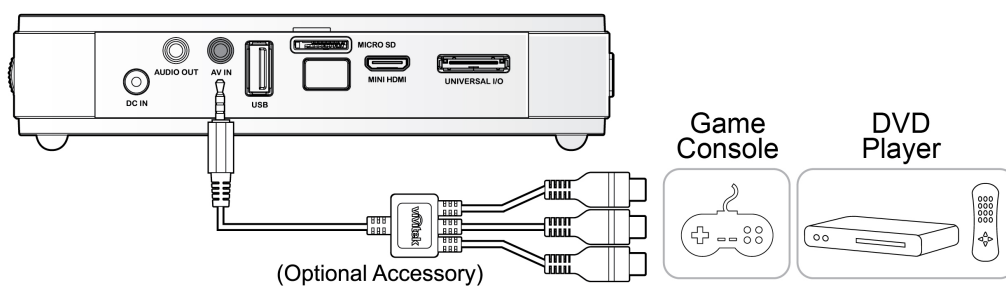

## Connecting Audio

Connect earphones or mini speakers to the Qumi by inserting into the Audio Out port.

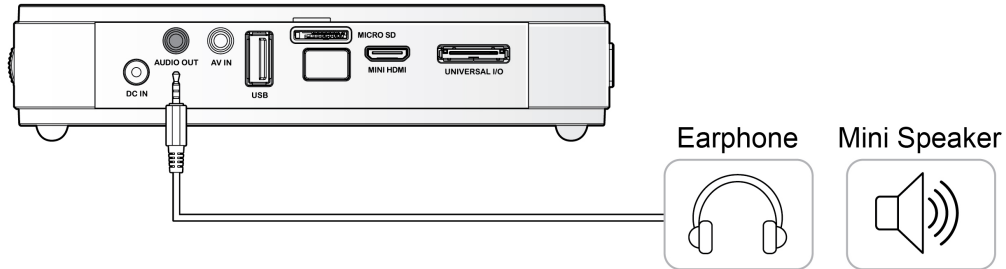

## Starting and Shutting down the Qumi

1. Connect the AC power adapter to the Qumi. Connect the other end of the AC power adapter to a wall outlet.

**Note:**  
Adapter models may vary between regions.

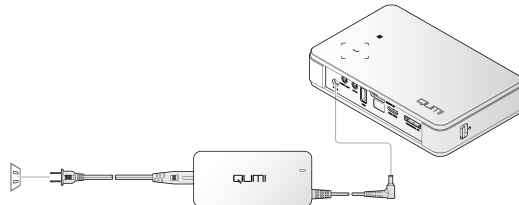

2. Then slide the **POWER** switch to turn on the Qumi.



The Qumi splash screen displays and connected devices are detected.

See *Setting an Access Password (Security Lock)* on page 10 if security lock is enabled.

**QUMI**

**3.** If more than one input device is connected, press the **SOURCE** button on the remote control and use the ▲ or ▼ buttons to select the applicable device or press ▲ and ▼ or ◀ and ▶ at the same time on the keypad on the Qumi.

- VGA: Analog RGB  
Component: DVD input  
YCbCr / YPbPr, or HDTV  
input YPbPr
- Composite Video: Traditional  
composite video
- HDMI: HDMI / DVI
- USB: microSD card / USB disc

**4.** Slide the **POWER** switch to turn off the Qumi.

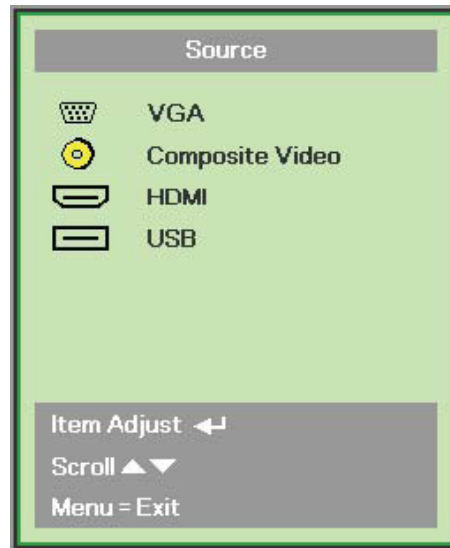

### Adjusting the Image

If the projected image is not clear, the image can be adjusted by moving the focus ring up or down until the image is clear.

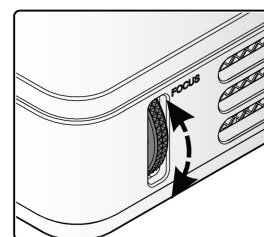

## Setting an Access Password (Security Lock)

To prevent unauthorized use of the Qumi, you can create a password. When the access password function is enabled, the password must be entered after the Qumi has been turned on.

Creating a password can be done by performing the following steps:

1. Press the **MENU** button on the remote control or press **MENU** and **←** on the keypad simultaneously to open the On-Screen Display (OSD) menu.

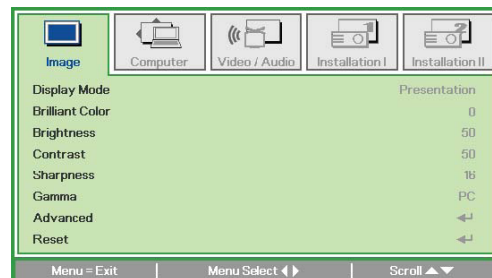

2. Move the cursor to the **Installation I** tab and scroll down to select **Advanced**.

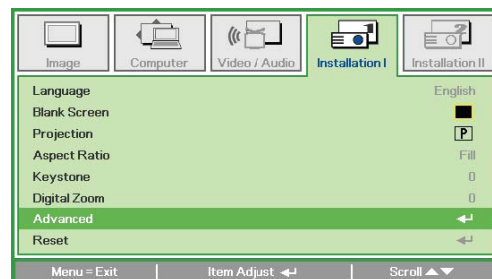

3. Press the **▲** or **▼** button to select **Security Lock**.

4. Press the **←** or **→** button to enable or disable the security lock function.

A password dialog box automatically appears.

5. You can use the **▲▼◀▶** buttons located either on top of the Qumi or on the remote control to enter the password. Any combination of the navigation buttons can be used (five must be chosen).

Press the navigation buttons in any order to set the password.

Then press the **MENU** button to exit the dialog box.

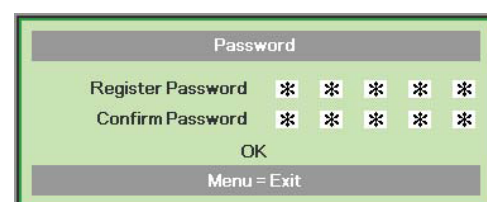
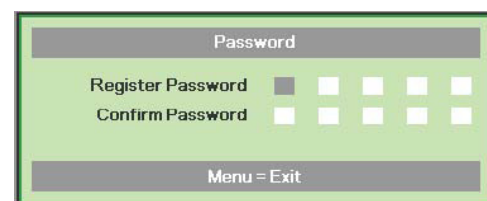
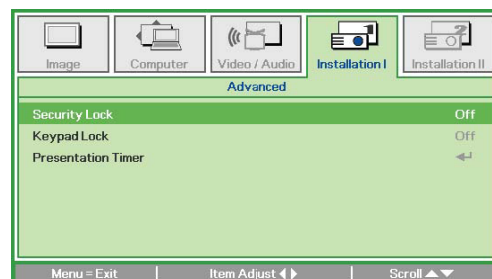



- 6.** The password confirmation menu appears when you power on the Qumi when the **Security Lock** is enabled.

Enter the password that was created in step 5.

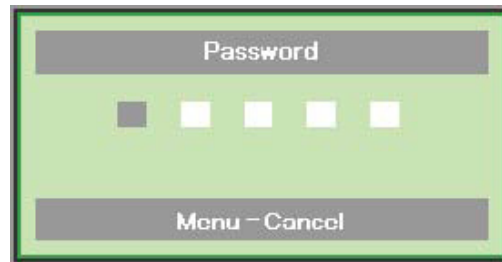

***Important:***

*Keep the password in a safe place. Without the password, you will not be able to use the Qumi. If you lose the password, contact your reseller for information on resetting the password.*

**Using a Tripod**

The Qumi can be used with a tripod by connecting the tripod to the bottom of the Qumi. Many typical tripods can be connected.

Supported Tripod Specifications:

- Type: Mini tripod
- Slot size: 1/4-20 L6.3 mm

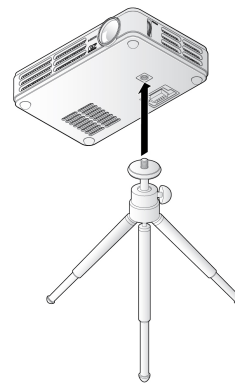

## Setting Up the Remote

The remote control comes with one (1) 3V lithium battery (CR2025). The battery is pre-installed in the remote control.

To begin using the remote control, remove the plastic tab (A) from the battery compartment.

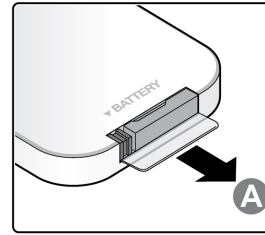

## Replacing the Remote Control Batteries

- 1.** Remove the battery compartment cover by sliding the cover towards the arrow (A). Then pull out the cover towards the arrow (B).
- 2.** Remove the old battery and insert the new battery with the positive side facing up.
- 3.** Install the cover.

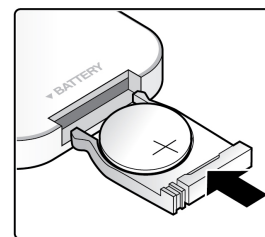
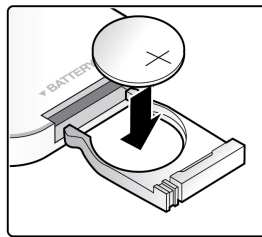
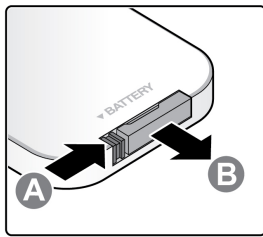

### **Caution:**

- 1.** Use only a 3V lithium battery (CR2025).
- 2.** Dispose of used batteries according to local ordinance regulations.
- 3.** Remove the battery when not using the Qumi for prolonged periods.

## Operating Range

The remote control uses infrared (IR) transmission to control the Qumi. It is not necessary to point the remote directly at the Qumi.

The remote control functions properly within a radius of approximately 7 meters (23 feet) and 15 degrees above or below the Qumi level (if the remote is not held perpendicular to the sides or rear of the Qumi).

If the Qumi is unresponsive to the remote control, move closer towards the Qumi.

## Chapter 3 Qumi Media Suite

### Overview

The Qumi Media Suite is designed to provide easy access to your files from an inserted microSD card or USB drive. Music, movies, pictures and documents can be displayed.



The media suite menu contains 5 applications that can be accessed:

- Movie – An easy to use movie player that displays multiple movie formats.
- Photo – A photo viewer that contains slide show functionality.
- Music – A music player that supports many types of audio files, ready to play music.
- Office viewer – A document viewer that displays documents.
- Settings – The settings of the Qumi can be adjusted in this menu.



## Movies



### Supported Formats

The following video formats are supported:

- H.264 video up to 720p at 30 frames per second; Main Profile level 3.1 with AAC-LC audio up to 160 Kbps, 48kHz, stereo audio in .m4v, .mp4, and .mov file formats
- MPEG-4 video up to 2.5 Mbps, 640 by 480 pixels at 30 frames per second; Simple Profile with AAC-LC audio up to 160 Kbps per channel, 48kHz, stereo audio in .m4v, .mp4, and .mov file formats
- Motion JPEG (M-JPEG) up to 35 Mbps, 1280 by 720 pixels, 30 frames per second, audio in U-Law, PCM stereo audio in .avi files

### Watching Your Movie

To open a list of movies, perform the following:

1. Press the ◀ or ▶ key to select the Movie icon in the media suite menu.
2. Press ↵ to open the file directory.
3. Select the folder containing the desired movie file.
4. Press ↵ to play the desired movie file.

While a movie is playing, the control interface can be hidden. To hide the control interface, press the ▲ key. Press the ▲ key again to show the control interface.

The control interface will automatically disappear if there is no user input for 5 seconds.

### Control Interface

The following playback functions are controlled by the remote control, which are shown in the table below:

ACTION	DESCRIPTION
Pause/Resume	Press ↵ to pause or resume a movie
Forward speed	Press the ◀ or ▶ key to change the speed (2X, 4X, 8X, 16X, 32X)

# Photos



## Supported Formats

The photo viewer can open the following types of image files:

- BMP (up to 4000 x 3000 pixels)
- PNG (up to 4000 x 3000 pixels)
- JPG (up to 4000 x 3000 pixels)

## Viewing Your Photo

When a USB storage drive and/or a microSD card is inserted, the storage card folder icon will display in the file directory.

To open a photo in photo viewer, perform the following:

1. Press the ◀ or ▶ key to select the Photo icon in the media suite menu.
2. Press ⏪ to open the file directory.
3. Select the folder containing the desired photo.
4. Press ⏪ to display the desired photo.

To view the details of the photos, navigate to a photo. The details of the photo will appear on the bottom of the screen.

To view photos in full screen mode, perform the following:

1. Navigate to a photo.
2. Press ⏪ to view the photo in full screen mode.





To utilize the Zoom-In tool, press ⏪. (2X, 4X, 8X, 16X).

In order to zoom out to the default size of the image, press the Exit key.

While a photo is displayed, the control interface can be hidden. To hide the control interface, press the ▲ key. Press the ▲ key again to show the control interface.

## Control Interface

The photo viewer contains the following controls:

ICON	DESCRIPTION
	Return to the previous menu
	Sets the Slide Show interval
	View photos in Slide Show mode
	Rotate the photo in a counter-clockwise position
	Rotate the photo in a clockwise position



## Music



### Supported Formats:

The music player can play music files in the following formats:

- MP3 (up to 256Kbps bit-rate)
- WMA, MID, MIDI, MP1, MP2, OGG, AAC, AMR, WAV, AC3, M4A, AWB, APE

### Playing your Track

To open the music list, perform the following:

1. Press the ◀ or ▶ key to select the Music icon in the media suite menu.
2. Press ↵ to open the file directory.
3. Select the folder containing the desired song.
4. Press ↵ to play the desired song.

A song can be paused or can be played by selecting the Pause/Play button in the music player interface.







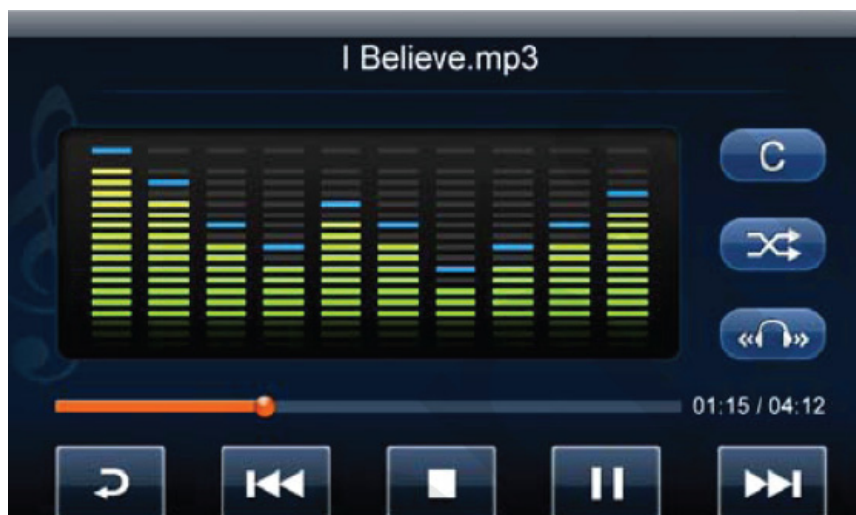

When the cursor is selecting the progress bar, a song can be paused or can be played by pressing ↵.

### Control Interface

The music player interface contains the following controls:



The music player provides controls to navigate through a song playlist. The following table provides a description the controls.

ICON	DESCRIPTION
 /  / 	Toggle speaker output to Left/Right/Stereo
 / 	Return to previous/Forward to next track
 / 	Pause/Play track
	Stop playback
	Return to the previous menu

The order of songs and playback mode can be adjusted. The following table provides a description of the playback modes.

ICON	DESCRIPTION
	Songs in the playlist will play in a continuous order
	All songs in the playlist will repeat
	Only the current song playing will repeat
	All songs in the playlist will be shuffled during playback

The music player contains many preset equalizer settings that can be applied. The following table provides a description of the different equalizer settings.

ICON	DESCRIPTION
	Normal
	Classical
	Jazz
	Pop
	Rock
	Bass



## Office Viewer



### Supported Formats

The document viewer in the Qumi Media Suite can open the following types of documents:

- Microsoft® Word (97-2007, .doc/.docx)
- Microsoft® PowerPoint (97-2007, .ppt/.pptx)
- Microsoft® Excel (97-2007, .xls/.xlsx)
- Adobe® PDF (.pdf)
- Text (.txt)

### Selecting Your Document

To open a file in document viewer, perform the following:

1. Press the ◀ or ▶ key to select the office viewer icon in the media suite menu.
2. Press ↵ to open the file directory.
3. Select the folder containing the desired file.
4. Press ↵ to display the desired file.

Once a file is open, press ↵ to zoom in for a larger view of the file. Files can be zoomed in 2X, 4X, 8X and 16X views. Use the navigation keys to move the view of the file.

To proceed to the next page or return to a previous page, press the ▲ or ▼ keys.

#### **Note:**

*You cannot move to the previous or next page if the view is zoomed in.*

### Control Interface

The office viewer does not contain a dedicated control interface.





## Settings



### System Options

The system options menu displays the system and firmware information. The Information menu provides details about the software version.

### Play Mode

The play mode menu displays settings for both video and music player options. The following settings are available:

- Repeat None – The videos or music tracks will not repeat after it is completed.
- Shuffle – The order of videos or music tracks will play in a random order.
- Repeat One – A selected video or music track will continuously repeat after it is completed.
- Repeat All – All videos or music tracks in a playlist will repeat after all of the files in the playlist have been completed.

**Note:**

*The Qumi media suite always supplies an output of 1280x800 resolution to the system, so the OSD displays a resolution of 1280x800 as its received signal. This does not indicate the actual resolution of the actual multimedia files.*

### USB Options

The USB Mass Storage option allows you to connect a personal computer with a supported USB cable to transfer files between the Qumi and personal computer.

**Note:**

*The Qumi media suite only supports input from USB drives and MicroSD memory.*



## Chapter 4 On-Screen Display (OSD) Settings

### OSD Menu Controls

The Qumi has an On-Screen Display (OSD) settings menu that allows you to make adjustments and changes to settings, such as display settings and audio settings. There are 5 menus within the OSD menu:

- Image – Various aspects of the image quality can be adjusted in this menu.
- Computer – Settings for personal computers can be adjusted in this menu.
- Video/Audio – Many settings for video and audio can be adjusted in this menu.
- Installation I – Default language and other settings can be adjusted in this menu.
- Installation II – Factory reset and other settings can be adjusted in this menu.

If the interface is set on AV-IN, MINI HDMI or Universal I/O, the OSD menu can be accessed by pressing the **MENU** button on the remote control or keypad.

If the interface is set on the Qumi Media Suite menu, the OSD menu can be accessed by pressing the **MENU** button on the remote control or by simultaneously pressing **MENU** and **←** on the keypad.

#### Note:

If the OSD menu is inactive for 15 seconds, the OSD menu will close.

### Navigating the OSD

The remote control cursor buttons or the buttons on the top of the Qumi can be used to navigate and make changes to the OSD settings.

1. Enter the **OSD** menu.
2. Press the **←** or **→** button to move through the 5 menus.
3. Press the **▲** or **▼** button to move the cursor up and down within in a menu.
4. Press **←** or **→** to change the values for specific settings.
5. Press **MENU** button or **Exit** on the remote control to close the OSD or close a submenu.

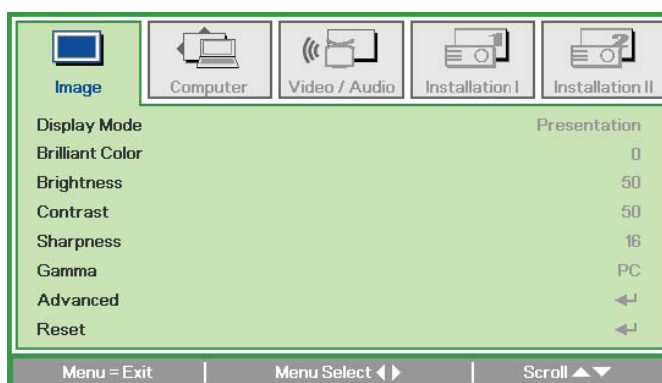

#### Note:

Depending on the video source, not all items in the OSD can be modified. For example, the **Horizontal/Vertical Position** items in the **Computer** menu can only be modified when the Qumi is connected to a PC through a VGA cable. Settings that are not enabled or that cannot be modified are gray in color.

## Setting the OSD Language

The language that is displayed in the OSD can be changed. To change the language in the OSD, perform the following steps:

1. Enter the **OSD** menu. Press the ◀ or ▶ button to select the **Installation I** menu.

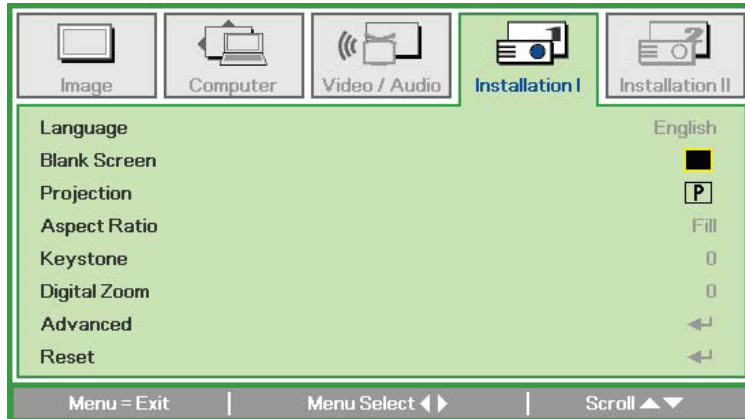

2. Press the ▲ or ▼ button until the cursor highlights the **Language** setting.

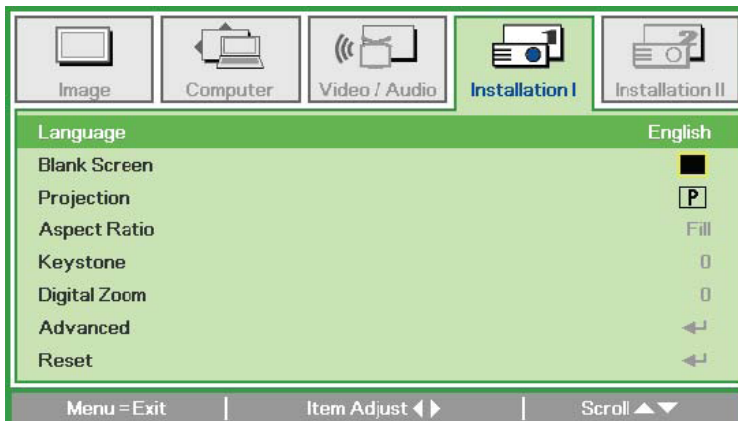

3. Press the ◀ or ▶ button until the language you want is shown in the cursor.
4. Press the **EXIT** button or **MENU** button twice to close the OSD.



# OSD Menu Overview

Use the following illustration to quickly find a setting or determine the range for a setting.

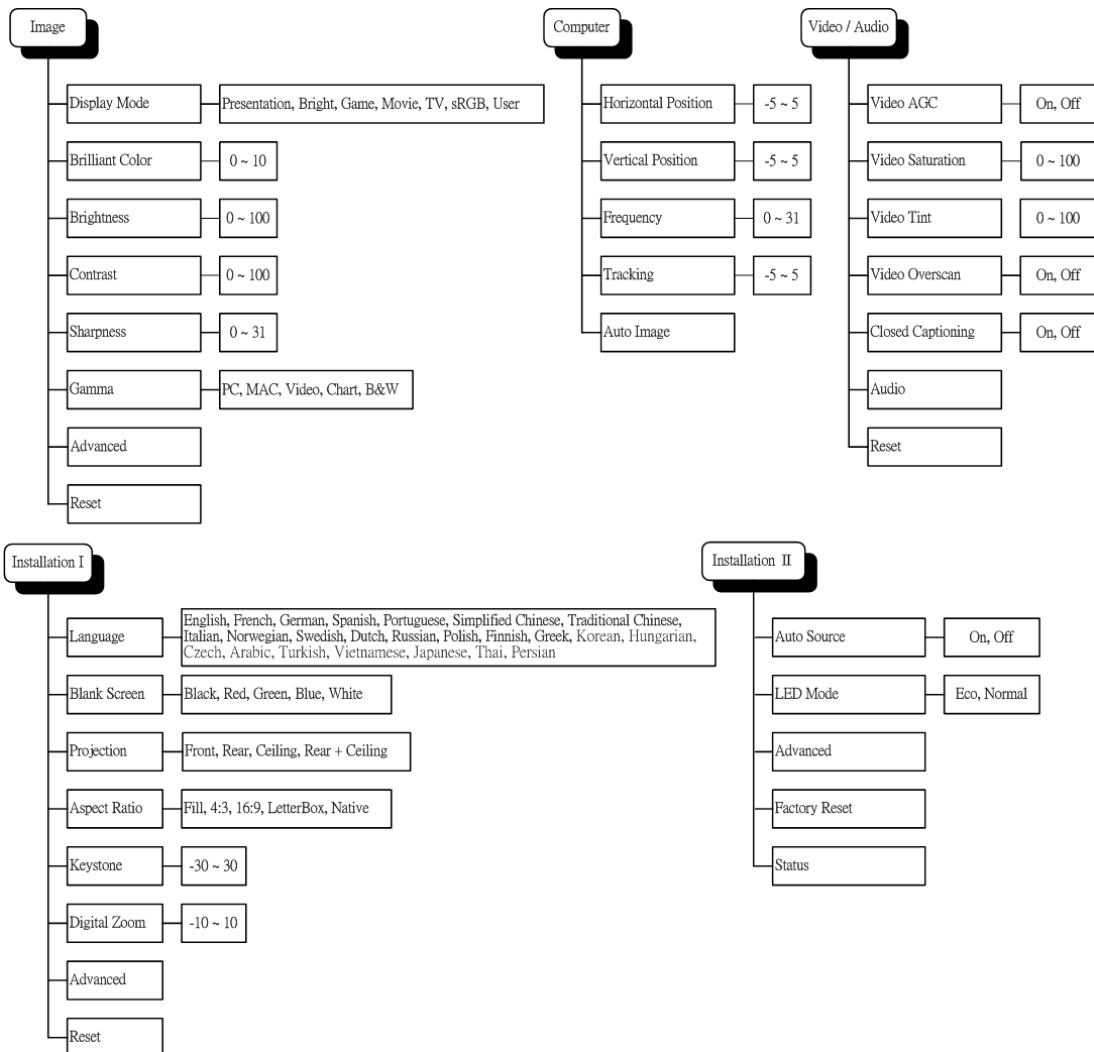

# OSD Sub-Menu Overview

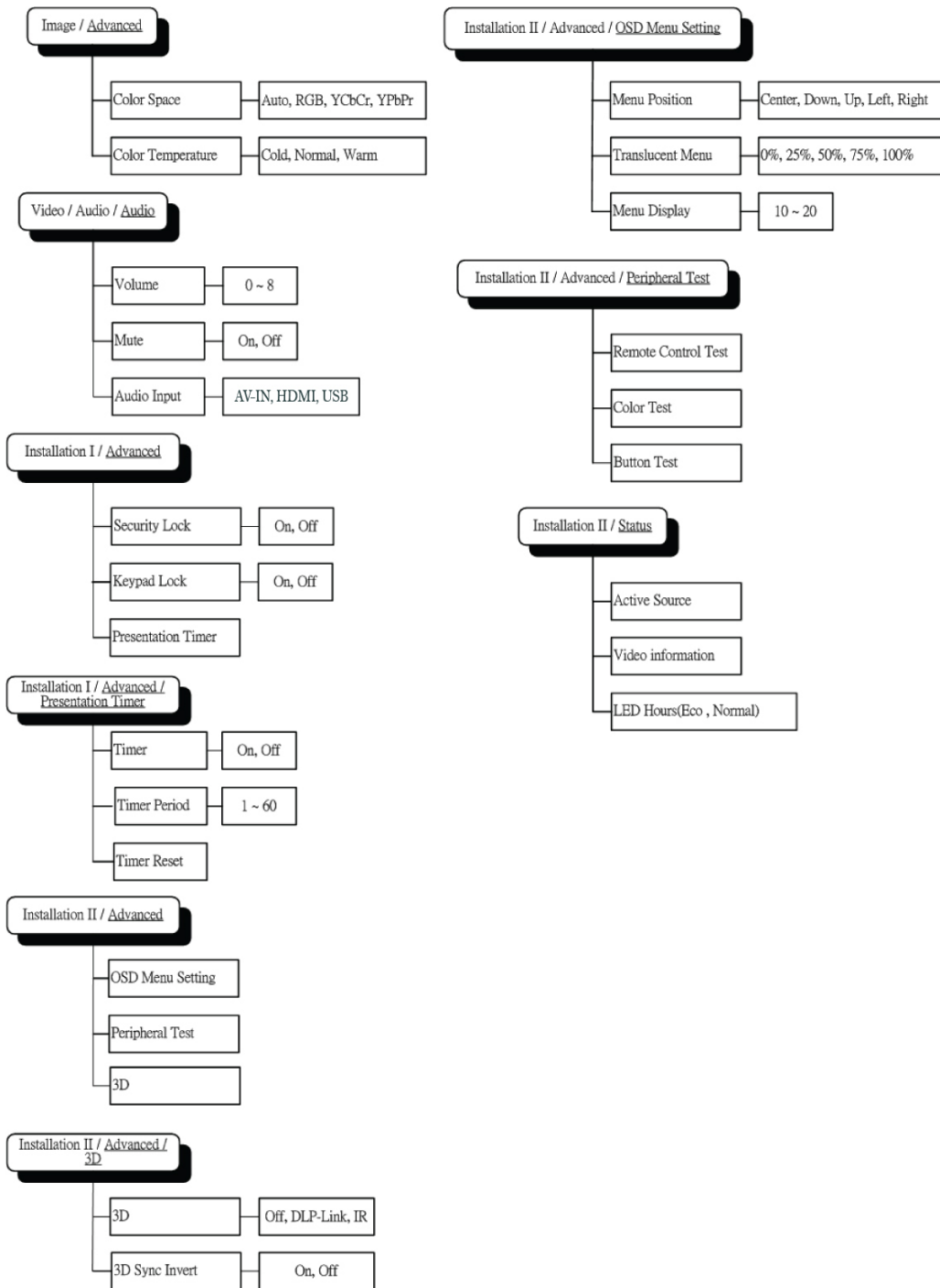

## Image Menu

To access the **Image** menu and adjust the settings, perform the following steps:

1. Enter the **OSD** menu.
2. Press the ◀ or ▶ button to select the **Image** menu.
3. Press the ▲ or ▼ button to move the cursor up or down in the **Image** menu.
4. Press the ◀ or ▶ button to change values for each applicable setting.

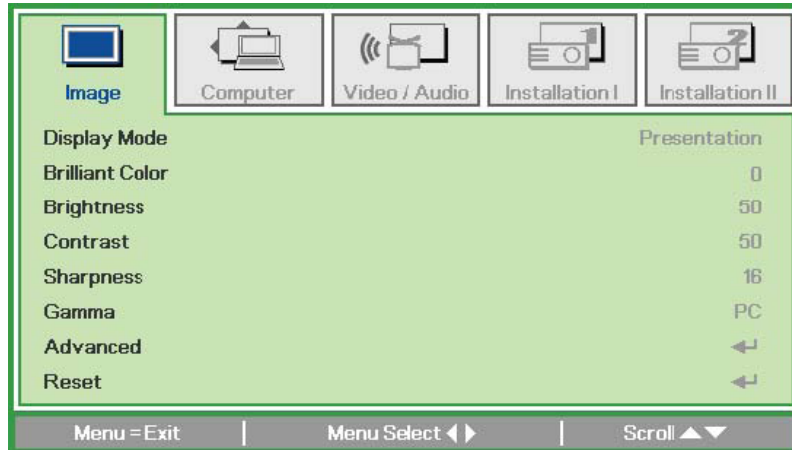

ITEM	DESCRIPTION
Display Mode	Press the ◀ or ▶ button to set the Display Mode.
Brilliant Color	Press the ◀ or ▶ button to adjust the Brilliant Color value.
Brightness	Press the ◀ or ▶ button to adjust the display brightness.
Contrast	Press the ◀ or ▶ button to adjust the display contrast.
Sharpness	Press the ◀ or ▶ button to adjust the display sharpness level.
Gamma	Press the ◀ or ▶ button to adjust the gamma correction of the display.
Advanced	Press ◀ to enter the Advanced menu. See <i>Advanced Feature</i> on page 25.
Reset	Press ◀ to reset all settings to default values.

**Note:**

*The Brilliant Color, Brightness, Contrast, Sharpness, Gamma and Advanced settings are adjustable only when the Display Mode is set to User.*

## Advanced Feature

To access the **Advanced** menu and adjust the settings, perform the following steps:

1. Enter the **OSD** menu.
2. Press the ◀ or ▶ button to select the **Image** menu.
3. Press the ▼ or ▲ button to move to the **Advanced** menu and then press ◀.
4. Press the ▼ or ▲ button to move the cursor up or down in the **Advanced** menu.

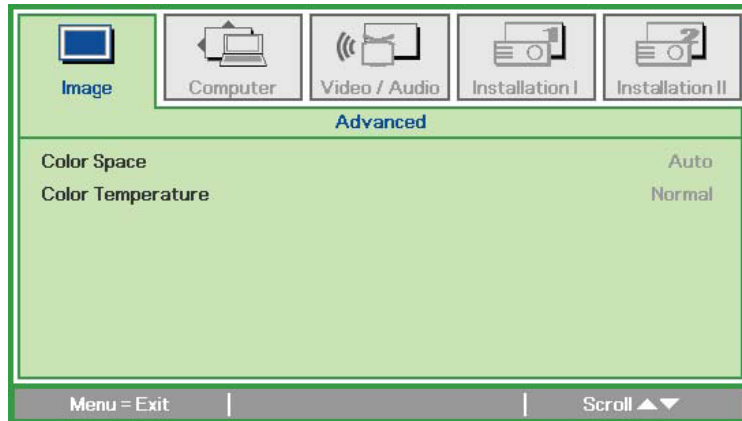

ITEM	DESCRIPTION
Color Space	Press the ◀ or ▶ button to adjust the color space.
Color Temperature	Press the ◀ or ▶ button to adjust the color temperature.



## Computer Menu

To access the **Computer** menu and adjust the settings, perform the following steps:

1. Enter the **OSD** menu.
2. Press the ◀ or ▶ button to select the **Computer** menu.
3. Press the ▲ or ▼ button to move the cursor up or down in the **Computer** menu.
4. Press the ◀ or ▶ button to change values for each applicable setting.

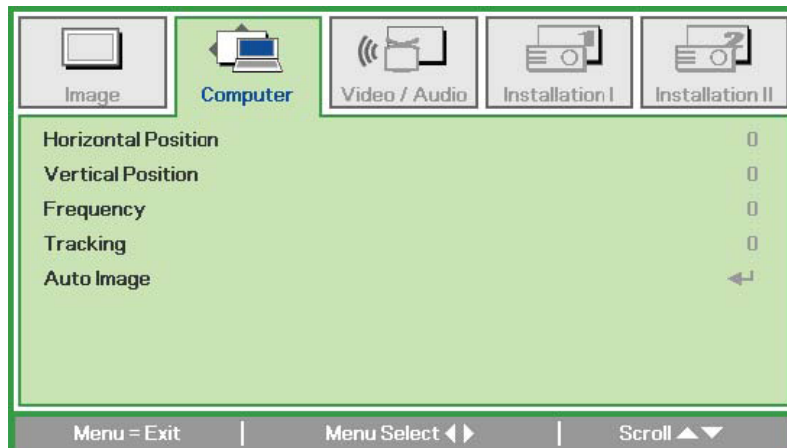

ITEM	DESCRIPTION
Horizontal Position	Press the ◀ or ▶ button to adjust the display position to left or right.
Vertical Position	Press the ◀ or ▶ button to adjust the display position to up or down.
Frequency	Press the ◀ or ▶ button to adjust the A/D sampling clock.
Tracking	Press the ◀ or ▶ button to adjust the A/D sampling dot.
Auto Image	Press ◀ to automatically adjustment for phase, tracking, size and position.

**Note:**

Items in the **Computer** menu can only be modified when the Qumi is connected to a PC through a VGA cable. Settings that are not enabled or that cannot be modified are gray in color.





## Video/Audio Menu

To access the **Video/Audio** menu and adjust the settings, perform the following steps:

1. Enter the **OSD** menu.
2. Press the ◀ or ▶ button to select the **Video/Audio** menu.
3. Press the ▲ or ▼ button to move the cursor up and down in the **Video/Audio** menu.
4. Press the ◀ or ▶ button to change values for each applicable setting.

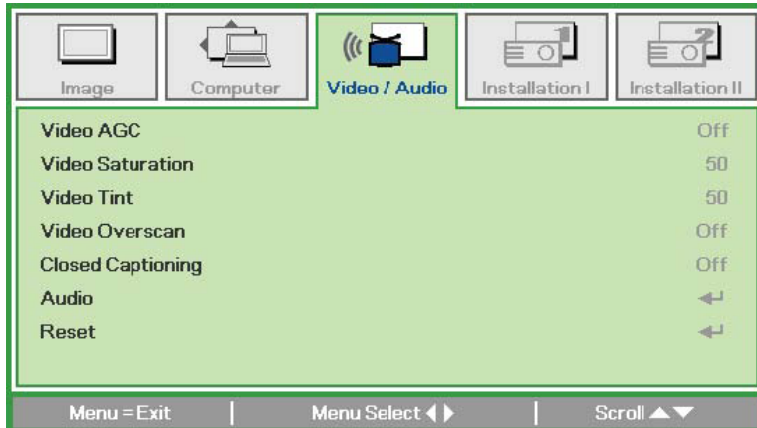

ITEM	DESCRIPTION
Video AGC	Press the ◀ or ▶ button to enable or disable the Automatic Gain Control for video source.
Video Saturation	Press the ◀ or ▶ button to adjust the video saturation.
Video Tint	Press the ◀ or ▶ button to adjust the video tint/hue.
Video Overscan	Press the ◀ or ▶ button to enable or disable video over scan.
Closed Captioning	Press the ◀ or ▶ button to enable or disable Closed Captioning.
Audio	Press ◀ to enter the Audio menu. See <i>Audio</i> on page 28.
Reset	Press ◀ to reset all settings to default values.

### Note:

*Video AGC, Video Saturation, Video Tint and Closed Caption settings are adjustable only when the source is from composite video. The Video Overscan settings are adjustable only when the source is from composite, component and HDMI video.*



## Audio

To adjust the audio settings, press **←** to enter the **Audio** sub menu.

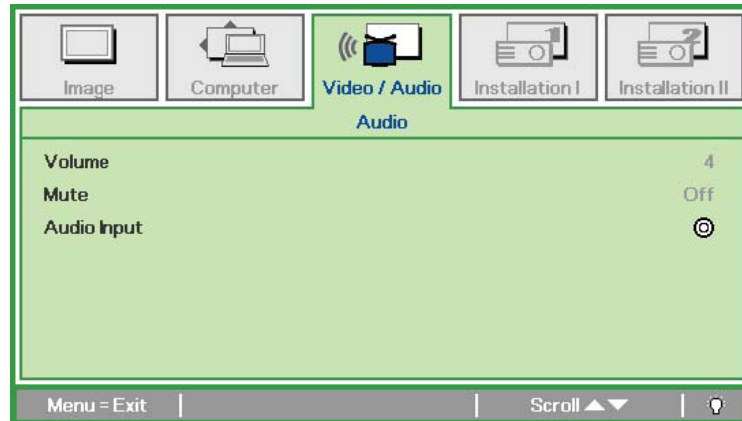

ITEM	DESCRIPTION
Volume	Press the ◀ or ▶ button to adjust the audio volume.
Mute	Press the ◀ or ▶ button to turn on or off the speaker.
Audio Input	Press the ◀ or ▶ button to select audio input.



## Installation I Menu

To access the **Installation I** menu and adjust the settings, perform the following steps:

1. Enter the **OSD** menu.
2. Press the ◀ or ▶ button to select the **Installation I** menu.
3. Press the ▲ or ▼ button to move the cursor up or down in the **Installation I** menu.
4. Press the ◀ or ▶ button to change values for each applicable setting.

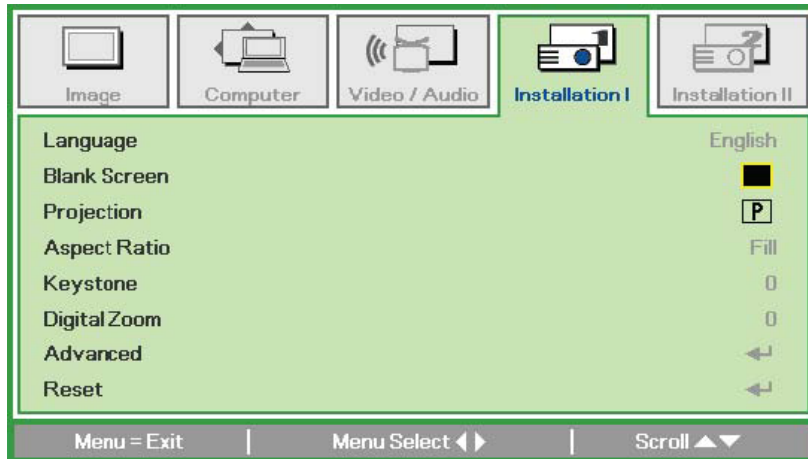

ITEM	DESCRIPTION
Language	Press the ◀ or ▶ button to select a different localization menu.
Blank Screen	Press the ◀ or ▶ button to select different color to blank the screen.
Projection	Press the ◀ or ▶ button to choose from four projection methods: Front, Rear, Ceiling-Front, Ceiling-Rear.
Aspect Ratio	Press the ◀ or ▶ button to adjust the video aspect ratio.
Keystone	Press the ◀ or ▶ button to adjust the display keystone.
Digital Zoom	Press the ◀ or ▶ button to adjust the Digital Zoom menu.
Advanced	Press ◀ to enter the Advanced menu. See <i>Advanced</i> on page 30.
Reset	Press ◀ to reset all settings to default values (except Language and Security Lock).



## Advanced

To adjust the advanced settings, press **←** to enter the **Advanced** sub menu.

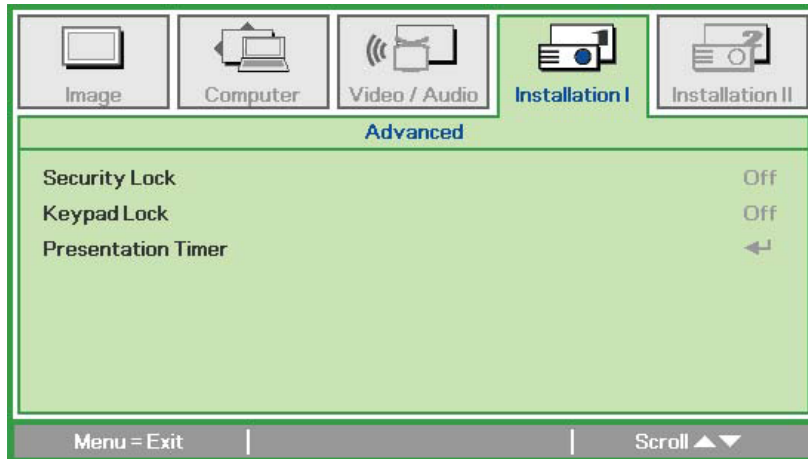

ITEM	DESCRIPTION
Security Lock	Press the <b>◀</b> or <b>▶</b> button to enable or disable security lock function.
Keypad Lock	Press the <b>◀</b> or <b>▶</b> button to enable or disable keypad lock function.
Presentation Timer	Press <b>←</b> to enter the Presentation menu.

## *Presentation Timer*

To adjust the presentation timer settings, press **←** to enter the **Presentation Timer** sub menu.

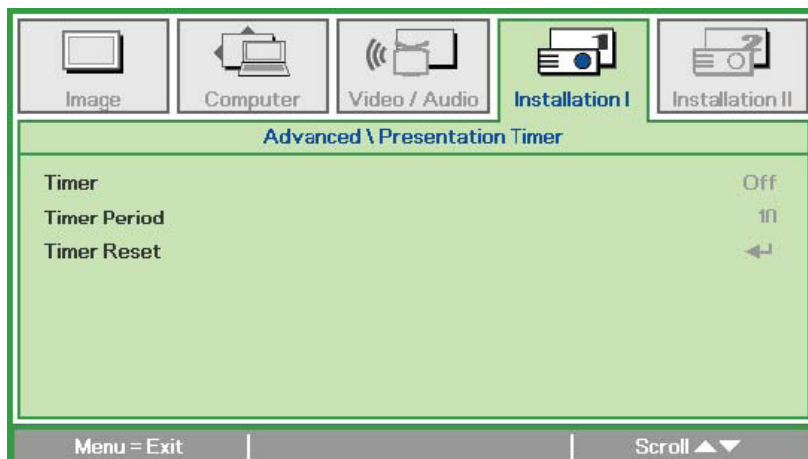

ITEM	DESCRIPTION
Timer	Press the <b>◀</b> or <b>▶</b> button to enable or disable presentation timer function.
Timer Period	Press the <b>◀</b> or <b>▶</b> button to adjust the display timer period.
Timer Reset	Press <b>←</b> to reset presentation timer counter.



## Installation II Menu

To access the **Installation II** menu and adjust the settings, perform the following steps:

1. Enter the **OSD** menu.
2. Press the ◀ or ▶ button to select the **Installation II** menu.
3. Press the ▲ or ▼ button to move the cursor up or down in the **Installation II** menu.

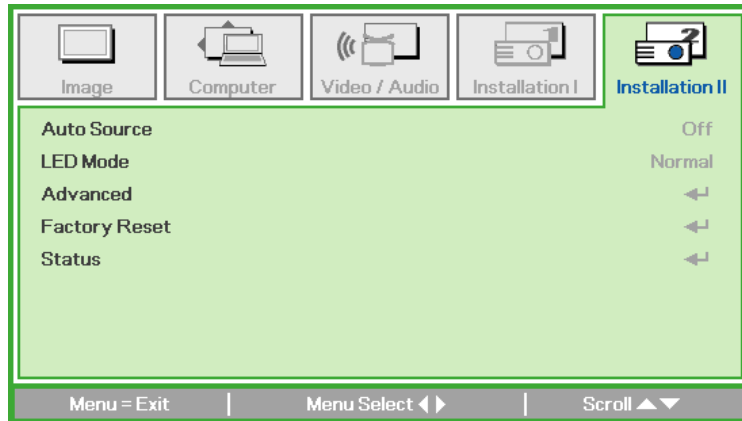

ITEM	DESCRIPTION
Auto Source	Press the ◀ or ▶ button to enable or disable automatic source detection.
LED Mode	Press the ◀ or ▶ button to select the LED mode for higher brightness or lower brightness to save LED life.
Advanced	Press ◀ to enter the Advanced menu. See <i>Advanced Feature</i> on page 32.
Factory Reset	Press ◀ to reset all items to factory preset values.
Status	Press ◀ to enter the Status menu. See page 35 for more information on Status.



## Advanced Feature

To access the **Advanced** menu and adjust the settings, perform the following steps:

1. Enter the **OSD** menu.
2. Press the ◀ or ▶ button to select the **Installation II** menu.
3. Press the ▲ or ▼ button to select the **Advanced** menu and then press ←.
4. Press the ▲ or ▼ button to move the cursor up or down in the **Advanced** menu.
5. Press the ◀ or ▶ button to change values for each applicable setting.

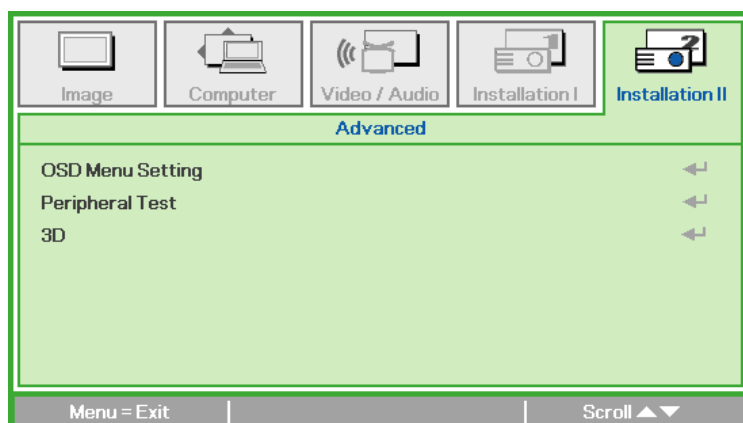

ITEM	DESCRIPTION
OSD Menu Setting	Press ← to enter the OSD setting menu. See page 33 for more information on OSD Menu Setting.
Peripheral Test	Press ← to enter the Peripheral Test menu. See page 33 for more information on Peripheral Test.
3D	Press ← to enter the 3D menu. See 3D on page 34.

### **Note:**

To use the 3D function, the Play Movie in 3D setting found in your player under the 3D Disc Menu must be enabled. 3D functionality works when the input source supports 120Hz.

## OSD Menu Setting

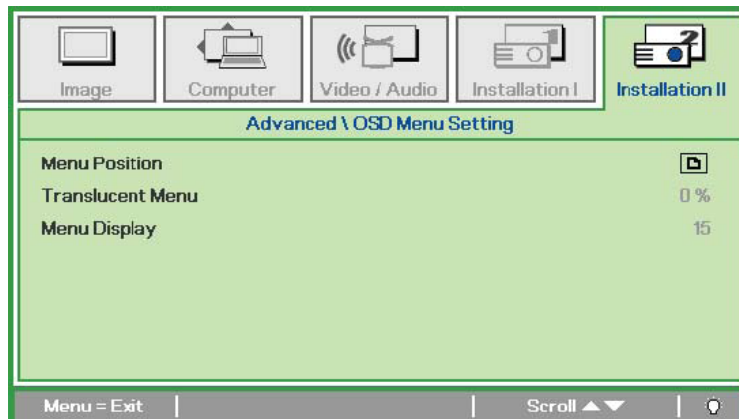

ITEM	DESCRIPTION
Menu Position	Press the ◀ or ▶ button to select different OSD location.
Translucent Menu	Press the ◀ or ▶ button to select OSD background translucent level.
Menu Display	Press the ◀ or ▶ button to select OSD timeout delay.

## Peripheral Test

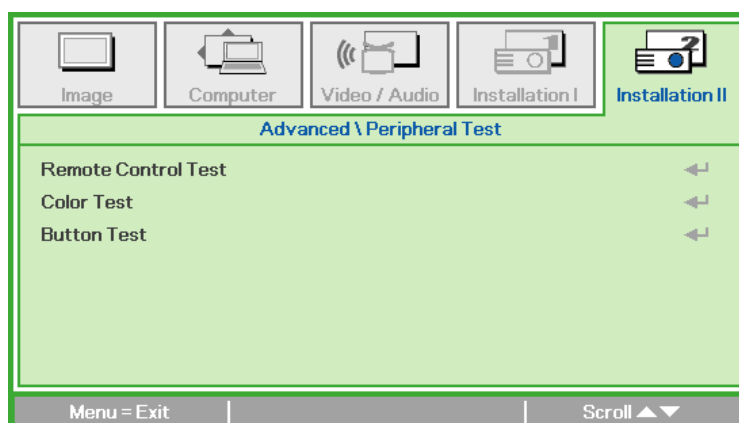

ITEM	DESCRIPTION
Remote Control Test	Press ◀ to test the IR remote controller for diagnostic.
Color Test	Press ◀ to select different colors on screen.
Button Test	Press ◀ to test the button on keypad.



## 3D

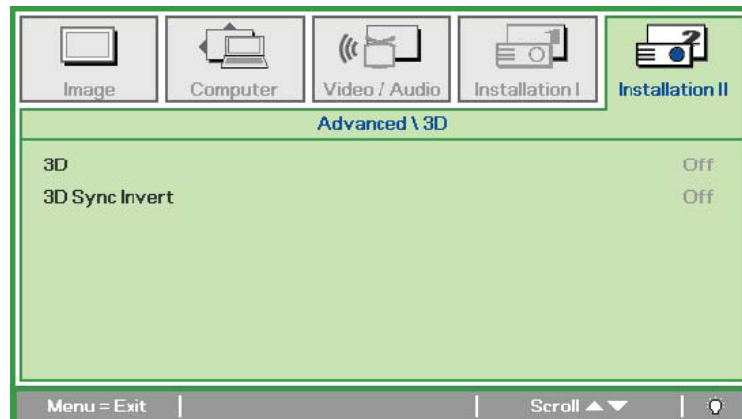

ITEM	DESCRIPTION
3D	Press the ◀ or ▶ to select Off, DLP-Link or IR.
3D Sync Invert	Press the ◀ or ▶ to turn 3D Sync Invert On or Off.

## Factory Reset

To reset all of the menu items to the factory default values (except Language and Security Lock), perform the following steps:

1. Press the ▲ or ▼ button to move the cursor up or down in the **Installation II** menu.
2. Select the **Factory Reset** sub menu.
3. Press ◀.

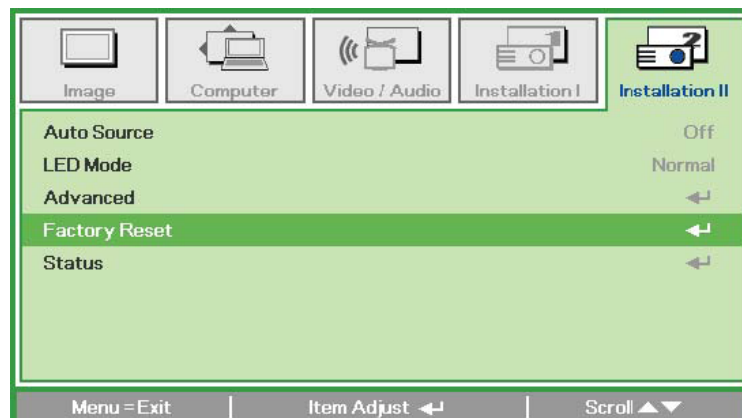



## Status

To see the status of the Qumi, perform the following steps:

1. Press the ▲ or ▼ button to move the cursor up or down in the **Installation II** menu.
2. Select the **Installation II** sub menu
3. Press ← to enter the **Status** sub menu.

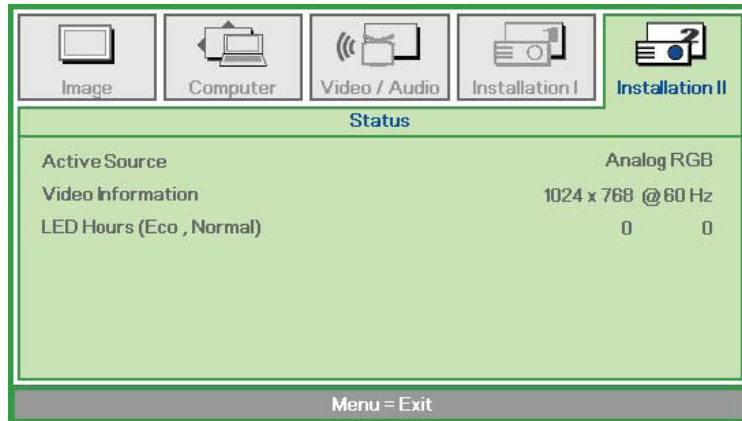

ITEM	DESCRIPTION
Active Source	Displays the activated source.
Video Information	Displays resolution/video information for RGB source and color standard for Video source.
LED Hours	LED use information is displayed (in hours). Eco and Normal counters are separated.



## Chapter 5 Taking Care of Your Qumi

### Cleaning the Qumi

Cleaning the Qumi to remove dust and grime will help provide trouble-free operation.

**Warning:**

1. The Qumi should be turned off and unplugged before cleaning. Failure to do so may result in injury or damage to the system.
2. Use only a dampened cloth when cleaning. Do not allow water to enter the ventilation openings on the Qumi.
3. If a small amount of water gets into the interior of the Qumi while cleaning, unplug the Qumi and set in a well ventilated area for several hours before using.
4. If a large amount of water gets into the interior of the Qumi when cleaning, unplug the Qumi and have it serviced.

### Cleaning the Lens

Optical lens cleaning solutions can be purchased from most camera and other retail stores. To clean the Qumi lens, perform the following steps:

1. Apply a small amount of the optic lens cleaning solution to a clean and soft cloth. (Do not apply the cleaning solution directly to the lens.)
2. Gently wipe the lens in a circular motion.

**Caution:**

1. Do not use abrasive cleaners or solvents.
2. To prevent discoloration or fading, do not allow the cleaning solution to contact the Qumi case.



# Troubleshooting

## Common Problems and Solutions

These guidelines provide tips to deal with problems you may encounter while using the Qumi. If the problem remains unresolved, contact your dealer for assistance.

The problem sometimes can be as simple as a wire that is not completely connected. Review the following possible issues before proceeding to the problem-specific solutions.

- Use another electrical device to confirm that the electrical outlet is properly working.
- Make sure that the Qumi is turned on.
- Make sure all connections are securely connected.
- Make sure that the connected device is turned on.
- Make sure that the connected PC is not in suspend or sleep mode.
- Make sure the connected notebook computer is properly configured for an external display.

## Tips for Troubleshooting

In each problem-specific section, perform the steps in the order suggested. Doing so may help solve the problem more quickly.

In order to avoid replacing non-defective parts, try to find and isolate the problem.

For example, if you replace batteries and the problem remains, put the original batteries back and move to the next step.

Keep a record of the steps you take when troubleshooting. The information may be useful for reference when calling technical support or for bringing the Qumi to service personnel.

## LED Error Messages

ERROR CODE MESSAGES	LEFT KEY BLUE BLINK	RIGHT KEY BLUE BLINK
Over temperature error (Inlet air )	3	OFF
LED over temperature (Red)	3	1
LED over temperature (Green)	3	2
LED over temperature (Blue)	3	3
Fan 1 (Blower) error	6	1
Fan 2 (System) error	6	2
Red LED Thermistor error	8	1
Green LED Thermistor error	8	2
Blue LED Thermistor error	8	3

In the event of an LED error, disconnect the AC power cord and wait for one (1) minute before restarting the Qumi.

If there is any other situation that isn't listed in the chart above, please contact your service center.



## Image Problems

### **Problem: No image appears on the screen**

1. Verify that the settings on your personal computer are properly configured.
2. Turn off all of the equipment and power up the equipment again in the correct order.

### **Problem: The image is blurred**

1. Adjust the Focus on the Qumi.
2. Make sure the Qumi-to-screen distance is within the specified range.
3. Clean the Qumi lens with optical lens cleaning cloth if it is dirty.

### **Problem: The image is wider at the top or bottom (trapezoid effect)**

1. Position the Qumi so that it is perpendicular to the screen as much as possible.
2. Adjust the Keystone settings in the OSD to correct the problem.

### **Problem: The image is reversed**

Check the orientation of the Projection setting in the Installation I menu in the OSD.

### **Problem: The image is streaked**

1. Set the Frequency and Tracking settings on the Computer menu in the OSD to the default settings.
2. Connect the Qumi to another computer to make sure that the problem is not caused by a computer's video card.

### **Problem: The image is flat with no contrast**

Adjust the Contrast setting in the Image menu in the OSD.

### **Problem: The color of the projected image does not match the source image**

Adjust the Color Temperature and Gamma settings in the Image menu in the OSD.

## Remote Control Problems

### **Problem: The Qumi does not respond to the remote control**

1. Aim the remote control towards remote sensor on the Qumi.
2. Make sure the path between remote and sensor is not obstructed.
3. Turn off any fluorescent lights in the room.
4. Check to see if the battery polarity is correct.
5. Replace the batteries.
6. Turn off other Infrared-enabled devices in the vicinity.
7. Have the remote control serviced.



## Audio Problems

### **Problem: There is no sound**

1. Adjust the volume of the audio source.
2. Check the audio cable connection.
3. Test the output of the audio source with other speakers.
4. Have the Qumi serviced.

### **Problem: The sound is distorted**

1. Check the audio cable connection.
2. Test the output of the audio source with other speakers.
3. Have the Qumi serviced.

## FAQs

### **1. Does Qumi work with a personal computer, notebook or netbook?**

Yes. Use the provided VGA cable or HDMI cable. The Qumi can connect to a PC, notebook or netbook if they have an appropriate HDMI or VGA port. To play audio, a separate 3.5mm stereo mini-jack audio cable is required to connect to the Qumi's audio port.

### **2. Is it possible to connect the Qumi to a game console, such as a Microsoft® Xbox or Sony® PS3?**

Yes. The Qumi can be used to display content from an Xbox or PS3 console. This can be done by connecting the HDMI cable from the game console to the Qumi.

### **3. Can the Qumi project content from a television?**

Watching television content can be done by connecting a cable box, digital set-top-box or satellite receiver because televisions are only able to produce images on its own screen. For example, if a cable box is used, it can be connected by an HDMI cable to the Qumi.

### **4. How can an iPad® connect to the Qumi?**

An Apple® iPad to VGA converter cable is required. To connect it to the Qumi, connect the cable from the iPad to the converter. The VGA converter can then be connected to the Qumi. The output of the iPad will be properly resized to fit the Qumi's native resolution and full screen view.





**5. How are images from a digital camera or a USB storage device displayed?**

Images and other content can be displayed by connecting the following devices to the Qumi:

- USB flash drive, hard drive, card reader
- Digital camera
- Smart phone
- microSD card
- Multimedia storage viewer

Once the devices are connected, images can be displayed by using the Qumi Media Suite.

**6. Which cable is required to video devices to the Qumi?**

Video devices can be connected to the Qumi by using an Audio/Video or HDMI cable if the devices contain the appropriate ports. To play audio, a separate stereo mini-jack adapter cable (3.5mm mini plug and two RCA plugs). An RCA cable connected can also be connected to the Qumi.

**7. What type of video formats does the Qumi support?**

H.264, MPEG-4, VC-1, WMV9, DivX(Xvid), Real Video, AVS and MJPEG.

**8. What type of audio formats does the Qumi support?**

MP3 and WMA.

**9. What type of document formats does the QUMI support?**

Microsoft® Office 2003 and Microsoft® Office 2007 (Word, Excel®, PowerPoint®), Adobe® PDF and text files (txt).

**10. What type of photo formats does the QUMI support?**

JPEG, PNG and BMP.

**11. How long will the LED light source in the Qumi last and can it be replaced?**

The Qumi does not use a typical Qumi lamp. It uses a set of Light Emitting Diodes (LED) to illuminate and project images. LED's have a greater lifespan than conventional lamps. Qumi LED's are estimated to last for approximately 30,000 hours. The lifespan of the LED depends on factors such as brightness, usage, environmental conditions. LED brightness can decrease over time. The LED module is not replaceable.

**12. Why do I need to re-adjust the focus on my Qumi after it's powered up?**

For the best picture quality, adjustment of the focus ring may be necessary once the operational temperature has been met.

## **Vivitek Support Site**

Please visit [www.vivitekcorp.com](http://www.vivitekcorp.com) for more information, support and product registration.

## Specifications

Model	Qumi Q2 Series
Resolution	HD (720p - 1280x800)
Projection Distance	1000mm ~ 3000mm (39.37" ~ 118.11")
Projection Screen Size (Diagonal)	762mm ~ 2286mm (30" ~ 90")
Projection Lens	Manual focus
Throw Ratio	1.55x
Vertical Keystone Correction	+/- 30 steps
Projection Methods	Front, Rear, Desktop, Front-Ceiling, Rear-Ceiling
Data Compatibility	VGA, SVGA, XGA, SXGA, SXGA+, UXGA, Mac
SDTV/EDTV/ HDTV	480i, 480p, 720p, 1080i, 1080p
Video Compatibility	HDTV (720p, 1080i/p), NTSC/NTSC 4.43, PAL (B/G/H/I/M/N/60), SECAM
Safety Certification	FCC-B, UL, CCC, CE, C-Tick, KC, CB, SASO, NOM, PCT, RoHS, PSB, ICES-003(Canada)
Operation Temperature	5° ~ 35°C
Dimensions (WxHxD)	160.0mm (6.3") x 102.4mm (4.03") x 32.3mm (1.27")
AC Input	AC Universal 100 - 240, Typical @ 110VAC (100-240)/+/-10%
Power Consumption	65W
Audio Speaker	1W mono speaker
Input Terminals	VGA (through 24-pin connector) x 1
	3.5mm AV IN x 1
	Mini HDMI™ x 1
	USB type A x 1
	microSD x 1
Output Terminals	3.5mm earphone jack (volume control) x 1

**Note:**

*For questions regarding product specifications, please contact your local distributor.*



## Projection Distance vs. Projection Size

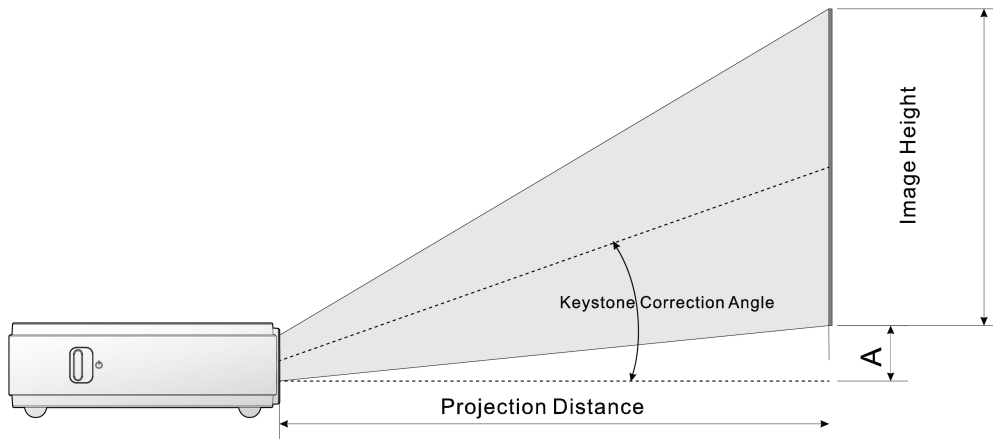

## Projection Distance and Size Table

IMAGE DIAGONAL (MM/INCHES)	IMAGE WIDTH (MM/INCHES)	IMAGE HIGH (MM/INCHES)	PROJECTION DISTANCE (MM/INCHES)	OFFSET-A (MM/INCHES)
762/30	646/25.43	404/15.91	1000/39.37	10/0.40
1016/40	862/33.94	538/21.18	1340/52.76	13/0.51
1143/45	969/38.15	606/23.86	1500/59.06	15/0.59
1270/50	1077/42.40	673/26.50	1670/65.75	17/0.66
1524/60	1292/50.87	808/31.81	2000/78.74	20/0.79
1778/70	1508/59.37	942/37.09	2340/92.13	24/0.92
2032/80	1723/67.83	1077/42.40	2670/105.12	27/1.06
2286/90	1939/76.34	1212/47.72	3000/118.11	30/1.18





## Timing Mode Table

SIGNAL	RESOLUTION	H-SYNC (KHZ)	V-SYNC (HZ)	COMPOSITE / S-VIDEO	COMPONENT	RGB	DVI/HDMI
NTSC	—	15.734	60.0	O	—	—	—
PAL/SECAM	—	15.625	50.0	O	—	—	—
VESA	720 x 400	37.9	85.0	—	—	O	O
	640 x 480	31.5	60.0	—	—	O	O
	640 x 480	37.9	72.0	—	—	O	O
	640 x 480	37.5	75.0	—	—	O	O
	640 x 480	43.3	85.0	—	—	O	O
	800 x 600	35.2	56.0	—	—	O	O
	800 x 600	37.9	60.0	—	—	O	O
	800 x 600	48.1	72.0	—	—	O	O
	800 x 600	46.9	75.0	—	—	O	O
	800 x 600	53.7	85.0	—	—	O	O
	1024 x 768	48.4	60.0	—	—	O	O
	1024 x 768	56.5	70.0	—	—	O	O
	1024 x 768	60.0	75.0	—	—	O	O
	1024 x 768	68.7	85.0	—	—	O	O
	1280 x 800	49.7	59.8	—	—	O	O
	1280 x 800	62.8	74.9	—	—	O	O
	1280 x 800	71.6	84.8	—	—	O	O
	1280 x 1024	63.98	60.0	—	—	O	O
	1280 x 1024	79.98	75.0	—	—	O	O
	1280 x 1024	91.10	85.0	—	—	O	O
	1280 x 960	60.0	60.0	—	—	O	O
	1280 x 960	85.9	85.0	—	—	O	O
	1400 x 1050	65.3	60.0	—	—	O	O
	1440 x 900	70.6	75.0	—	—	O	O
1440 x 900	55.6	60.0	—	—	O	O	
1600 x 1200	75.0	60.0	—	—	O	—	
Apple® Mac	640 x 480	35.0	66.68	—	—	O	O
	832 x 624	49.725	74.55	—	—	O	O
	1024 x 768	60.24	75.0	—	—	O	O
	1152 x 870	68.68	75.06	—	—	O	O
SDTV	480i	15.734	60.0	—	O	—	O
	576i	15.625	50.0	—	O	—	O
EDTV	480p	31.469	60.0	—	O	—	O
	576p	31.25	50.0	—	O	—	O
HDTV	720p	37.5	50.0	—	O	—	O
	720p	45.0	60.0	—	O	—	O
	1080i	33.8	60.0	—	O	—	O
	1080i	28.1	50.0	—	O	—	O
	1080p	67.5	60.0	—	O	—	O
	1080p	56.3	50.0	—	O	—	O

O: Frequency supported

—: Frequency not supported

\*: Displayable level



## Qumi Dimensions

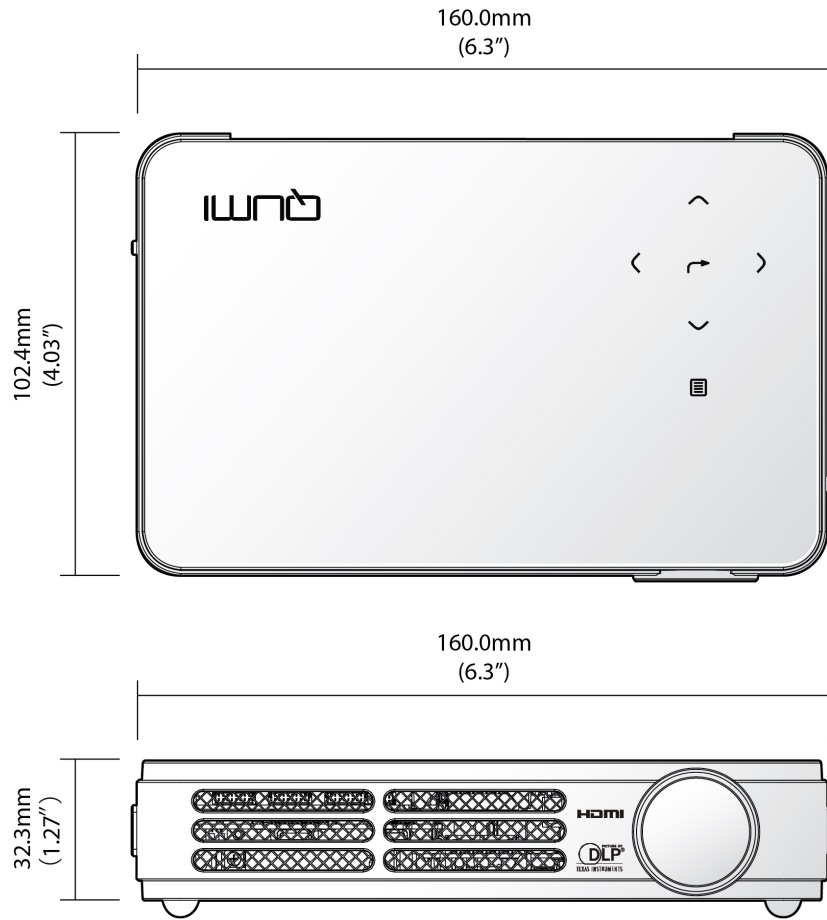

## Regulatory Compliance

### FCC Warning

This equipment has been tested and found to comply with the limits for a Class B digital device pursuant to Part 15 of the FCC Rules. These limits are designed to provide reasonable protection against harmful interference when the equipment is operated in a commercial environment.

This equipment generates, uses, and can radiate radio frequency energy and, if not installed and used in accordance with the instruction manual, may cause harmful interference to radio communications. Operation of this equipment in a residential area is likely to cause harmful interference in which case the user will be required to correct the interference at his/her own expense.

Changes or modifications not expressly approved by the parties responsible for compliance could void the user's authority to operate the equipment.

### Canada

This class B digital apparatus complies with Canadian ICES-003.

## Safety Certifications

FCC-B, UL, CCC, CE, C-Tick, KC, CB, SASO, NOM, PCT, RoHS, PSB, ICES-003 (Canada)

## Disposal and Recycling

This product may contain other electronic waste that can be hazardous if not disposed of properly. Recycle or dispose in accordance with local, state, or federal Laws. For more information, contact the Electronic Industries Alliance at [www.eiae.org](http://www.eiae.org).

